

SERVICE MANUAL

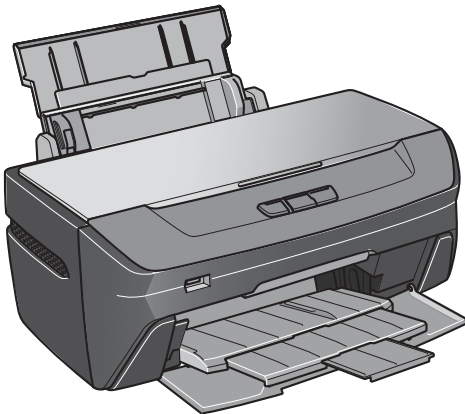
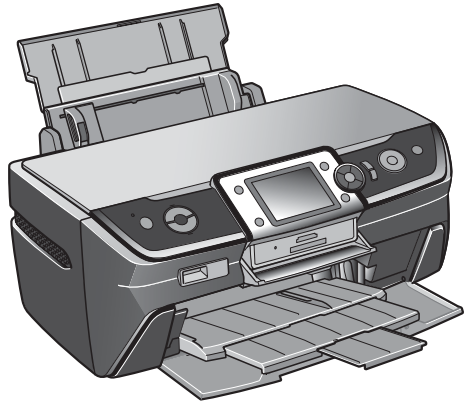

Color Inkjet Printer

**EPSON Stylus Photo R260/R265/R270
R360/R380/R390**

EPSON
EXCEED YOUR VISION

SEIJ06001

PRECAUTIONS

Precautionary notations throughout the text are categorized relative to 1) Personal injury and 2) damage to equipment.

DANGER Signals a precaution which, if ignored, could result in serious or fatal personal injury. Great caution should be exercised in performing procedures preceded by DANGER Headings.

WARNING Signals a precaution which, if ignored, could result in damage to equipment.

The precautionary measures itemized below should always be observed when performing repair/maintenance procedures.

DANGER

1. ALWAYS DISCONNECT THE PRODUCT FROM THE POWER SOURCE AND PERIPHERAL DEVICES PERFORMING ANY MAINTENANCE OR REPAIR PROCEDURES.
2. NO WORK SHOULD BE PERFORMED ON THE UNIT BY PERSONS UNFAMILIAR WITH BASIC SAFETY MEASURES AS DICTATED FOR ALL ELECTRONICS TECHNICIANS IN THEIR LINE OF WORK.
3. WHEN PERFORMING TESTING AS DICTATED WITHIN THIS MANUAL, DO NOT CONNECT THE UNIT TO A POWER SOURCE UNTIL INSTRUCTED TO DO SO. WHEN THE POWER SUPPLY CABLE MUST BE CONNECTED, USE EXTREME CAUTION IN WORKING ON POWER SUPPLY AND OTHER ELECTRONIC COMPONENTS.
4. WHEN DISASSEMBLING OR ASSEMBLING A PRODUCT, MAKE SURE TO WEAR GLOVES TO AVOID INJURIER FROM METAL PARTS WITH SHARP EDGES.

WARNING

1. REPAIRS ON EPSON PRODUCT SHOULD BE PERFORMED ONLY BY AN EPSON CERTIFIED REPAIR TECHNICIAN.
2. MAKE CERTAIN THAT THE SOURCE VOLTAGES IS THE SAME AS THE RATED VOLTAGE, LISTED ON THE SERIAL NUMBER/RATING PLATE. IF THE EPSON PRODUCT HAS A PRIMARY AC RATING DIFFERENT FROM AVAILABLE POWER SOURCE, DO NOT CONNECT IT TO THE POWER SOURCE.
3. ALWAYS VERIFY THAT THE EPSON PRODUCT HAS BEEN DISCONNECTED FROM THE POWER SOURCE BEFORE REMOVING OR REPLACING PRINTED CIRCUIT BOARDS AND/OR INDIVIDUAL CHIPS.
4. IN ORDER TO PROTECT SENSITIVE MICROPROCESSORS AND CIRCUITRY, USE STATIC DISCHARGE EQUIPMENT, SUCH AS ANTI-STATIC WRIST STRAPS, WHEN ACCESSING INTERNAL COMPONENTS.
5. REPLACE MALFUNCTIONING COMPONENTS ONLY WITH THOSE COMPONENTS BY THE MANUFACTURE; INTRODUCTION OF SECOND-SOURCE ICs OR OTHER NON-APPROVED COMPONENTS MAY DAMAGE THE PRODUCT AND VOID ANY APPLICABLE EPSON WARRANTY.
6. WHEN USING COMPRESSED AIR PRODUCTS; SUCH AS AIR DUSTER, FOR CLEANING DURING REPAIR AND MAINTENANCE, THE USE OF SUCH PRODUCTS CONTAINING FLAMMABLE GAS IS PROHIBITED.

About This Manual

This manual describes basic functions, theory of electrical and mechanical operations, maintenance and repair procedures of the printer. The instructions and procedures included herein are intended for the experienced repair technicians, and attention should be given to the precautions on the preceding page.

Manual Configuration

This manual consists of six chapters and Appendix.

CHAPTER 1.PRODUCT DESCRIPTIONS

Provides a general overview and specifications of the product.

CHAPTER 2.OPERATING PRINCIPLES

Describes the theory of electrical and mechanical operations of the product.

CHAPTER 3.TROUBLESHOOTING

Describes the step-by-step procedures for the troubleshooting.

CHAPTER 4.DISASSEMBLY / ASSEMBLY

Describes the step-by-step procedures for disassembling and assembling the product.

CHAPTER 5.ADJUSTMENT

Provides Epson-approved methods for adjustment.

CHAPTER 6.MAINTENANCE

Provides preventive maintenance procedures and the lists of Epson-approved lubricants and adhesives required for servicing the product.

APPENDIX Provides the following additional information for reference:

- Electrical circuit boards schematics

Symbols Used in this Manual

Various symbols are used throughout this manual either to provide additional information on a specific topic or to warn of possible danger present during a procedure or an action. Be aware of all symbols when they are used, and always read NOTE, CAUTION, or WARNING messages.



Indicates an operating or maintenance procedure, practice or condition that is necessary to keep the product's quality.



Indicates an operating or maintenance procedure, practice, or condition that, if not strictly observed, could result in damage to, or destruction of, equipment.



May indicate an operating or maintenance procedure, practice or condition that is necessary to accomplish a task efficiently. It may also provide additional information that is related to a specific subject, or comment on the results achieved through a previous action.



Indicates an operating or maintenance procedure, practice or condition that, if not strictly observed, could result in injury or loss of life.



Indicates that a particular task must be carried out according to a certain standard after disassembly and before re-assembly, otherwise the quality of the components in question may be adversely affected.

Revision Status

Revision	Date of Issue	Description
A	August 10, 2006	First Release
B	September 12, 2006	<p>Chapter 1</p> <p><i>1.7.5 Dimensions (p.22)</i> are changed.</p> <p>Chapter 2</p> <p><i>2.2.1 Main Features (p.26)</i> of C658Main Board is modified.</p> <p><i>2.2.3 Circuit Block Diagram (p.28)</i>: error correction</p> <p>Chapter 3</p> <p><i>3.2.1 Error Indication Method (p.33)</i>: EPSON Status Monitor 3 error messages are changed.</p> <p><i>3.3.1 Troubleshooting Problems with Error Messages (p.36)</i> is modified. (CR Encoder)</p> <p><i>3.4.4 Problems with Interfaces (p.55)</i>: Troubleshooting Memory Card are modified.</p> <p>Chapter 4</p> <p><i>4.1.4 Work Completion Checklist (p.59)</i>: Protection for Transportation is added.</p> <p><i>4.1.10 Disassembly/Assembly Procedures (p.64)</i>: the disassembly flowchart is modified.</p> <p><i>4.2.5 Upper Housing (p.68)</i>: the order of tighteing screws is corrected.</p> <p><i>4.2.9 Front Housing (p.73)</i> reassembly procedure is modified.</p> <p><i>4.3.1 Removing the USB Board (R260/R265/R270 only) (p.76)</i>: Cable Holder is corrected to "FFC Holder".</p> <p><i>4.3.3 Disassembling the Main Board Unit (p.80)</i>: the reassembly procedure is modified.</p> <p><i>4.3.4 Removing the Card Board (R360/R380/R390 only) (p.82)</i>: the procedure is moved after Main Board removal/disassembly procedure.</p> <p><i>4.5.3 Printhead (p.91)</i>: the caution on removal is modified.</p> <p><i>4.5.6 Stacker Assy (p.95)</i>: the caution on reinstallation is corrected.</p> <p>Chapter 5</p> <p><i>5.1.1 Servicing Adjustment Item List (p.113)</i> is modified.</p> <p><i>5.1.2 Replacement Part Adjustment Items (p.116)</i> is modified.</p> <p><i>5.2.1 Top Margin Adjustment (p.118)</i>: error correction.</p> <p><i>5.2.2 Head angular adjustment (p.118)</i> sample pattern is modified.</p> <p><i>5.2.4 PW Adjustment/First Dot Adjustment (p.120)</i>: error correction.</p> <p><i>5.2.6 PG Adjustment (p.122)</i> judging standard is corrected.</p> <p>Chapter 6</p> <p><i>6.1.3 Lubrication (p.131)</i>: Grease G-77 EPSON code is added.</p>

CONTENTS

Chapter 1 Product description

1.1 Overview	9
1.1.1 Differences between R260/265/270 and R360/380/390.....	9
1.2 Basic Specifications.....	10
1.2.1 Printing	10
1.2.2 Interfaces	11
1.3 Standalone Printing (R360/R380/R390 only)	13
1.3.1 Direct Print of Still Images.....	13
1.3.2 Direct Print of Movie Frames.....	14
1.4 Backup Function (R360/R380/R390 only).....	15
1.5 CD/DVD Print (R360/R380/R390 only).....	18
1.6 Operation Panel	19
1.6.1 Operation Panel	19
1.6.2 Indicator (LED)	20
1.7 Specifications Common to the Models.....	21
1.7.1 Electric Specifications	21
1.7.2 Environmental Condition	21
1.7.3 Durability.....	21
1.7.4 Noise Level.....	21
1.7.5 Dimensions	22

Chapter 2 Operating Principles

2.1 Overview	24
2.1.1 Printer Mechanism.....	24
2.1.2 Motors & Sensors	25
2.2 Electrical Circuit Operating Principles.....	26
2.2.1 Main Features	26
2.2.2 Components of Control Boards.....	27
2.2.3 Circuit Block Diagram	28
2.3 Banding Reduction System (BRS) / Paper Feed Amount Profile Correction (PFP)	30

Chapter 3 Troubleshooting

3.1 Overview	32
3.1.1 Troubleshooting on Motors and Sensors.....	32
3.2 Error/Warning Indications.....	33
3.2.1 Error Indication Method.....	33
3.3 Troubleshooting by Error Message	36
3.3.1 Troubleshooting Problems with Error Messages	36
3.4 Troubleshooting by Symptom	48
3.4.1 Problems in Printing Operation.....	48
3.4.2 Power Problems.....	53
3.4.3 Ink-related Problems	53
3.4.4 Problems with Interfaces	55

Chapter 4 Disassembly/Assembly

4.1 Overview	57
4.1.1 Precautions	57
4.1.2 Tools.....	58
4.1.3 Screws	58
4.1.4 Work Completion Checklist.....	59
4.1.5 Required Preparation before Disassembly	61
4.1.6 Orientation Definition	61
4.1.7 How to Unlock the Carriage.....	62
4.1.8 Sharp Metal Edges (Danger!).....	62
4.1.9 Differences in Disassembly Procedure by Model	63
4.1.10 Disassembly/Assembly Procedures.....	64
4.2 Removing Exterior Parts/Components.....	65
4.2.1 Paper Support	65
4.2.2 Printer Cover	65
4.2.3 Front Cover.....	66
4.2.4 Right Housing / Left Housing / USB Housing.....	66
4.2.5 Upper Housing	68
4.2.6 Panel Unit	69
4.2.7 EMI Frame / Waste Ink Tray	70

4.2.8	Right Front Housing / Left Front Housing	72
4.2.9	Front Housing	73
4.3	Removing Control Boards	76
4.3.1	Removing the USB Board (R260/R265/R270 only)	76
4.3.2	Removing the Main Board Unit	78
4.3.3	Disassembling the Main Board Unit	80
4.3.4	Removing the Card Board (R360/R380/R390 only)	82
4.3.5	Disassembling the Panel Unit	83
4.3.6	Middle Housing	86
4.4	Removing the Printer Mechanism	87
4.4.1	Removing the Printer Mechanism	87
4.5	Disassembly of the Printer Mechanism	89
4.5.1	CR Scale	89
4.5.2	APG Unit	90
4.5.3	Printhead	91
4.5.4	Waste Ink Pad	94
4.5.5	P/S Assy	94
4.5.6	Stacker Assy	95
4.5.7	Ink System	97
4.5.8	CR Motor	99
4.5.9	EJ Frame Assy	100
4.5.10	PF Encoder / PF Scale / PF Motor	102
4.5.11	ASF Unit	104
4.5.12	CR Unit	105
4.5.13	Upper Paper Guide	108
4.5.14	Front Paper Guide Assy/APG Sensor Assy	109
4.5.15	CDR Guide Detection Assy	111

Chapter 5 Adjustment

5.1	Adjustment Items and Overview	113
5.1.1	Servicing Adjustment Item List	113
5.1.2	Replacement Part Adjustment Items	116
5.2	Adjustment by Using Adjustment Program	118
5.2.1	Top Margin Adjustment	118
5.2.2	Head angular adjustment	118
5.2.3	Bi-D Adjustment	119
5.2.4	PW Adjustment/First Dot Adjustment	120
5.2.5	PF Adjustment	121
5.2.6	PG Adjustment	122

5.3	Banding Reduction System (BRS) Adjustment/ Paper Feed Amount Profile (PFP) Correction	124
5.3.1	Overview	124
5.3.2	Adjustment Procedure	125

Chapter 6 Maintenance

6.1	Overview	130
6.1.1	Cleaning	130
6.1.2	Service Maintenance	130
6.1.3	Lubrication	131

Chapter 7 Appendix

7.1	Exploded Diagram / Parts List	138
7.2	Electrical Circuits	138

CHAPTER

1

PRODUCT DESCRIPTION

1.1 Overview

Stylus Photo R260/R265/R270 and R360/R380/R390 are A4 home-use photo printers. Besides printing on papers, printing directly on CDs/DVDs are available. The main features are;

Printing

- Offers up to 5760(H) x 1440(V) dpi resolution
- 6-color individual ink cartridges
- Borderless, edge-to-edge photo printing is available for a variety of paper types provided by Epson
- High-speed and high-quality printing with UBEC, multi-common
- Front loading tray for CDs/DVDs
- Prints with a low noise level
- Supporting ESC/P-R Level-1 command offers printing of RGB data sent from a host PC.

Direct print from a memory card (R360/R380/R390 only)

- An incorporated memory card reader allows direct photo printing from a memory card.
- Convenient photo selection menus; “View and Print Photos” (number of copies can be set per photo), “Print All Photos”, “Print by Date”. Image edit functions such as “Zoom Print” are also provided.
- Supports superimposing of P.I.F. layout that conforms to Print Image Framer Ver.2 or Ver.3 on a selected photo.

Other special functions (R360/R380/R390 only)

- Doing layout with photos in a memory card for printing on CDs/DVDs and printing CD/DVD jackets can be made viewing the LCD.
- Movie files in a memory card can be played back and viewed on the LCD. Specifying a frame of the movie and printing it is available.

3.5inch 320X240 dot high-definition LCD (R360/R380/R390 only)

1.1.1 Differences between R260/265/270 and R360/380/390

Appearance

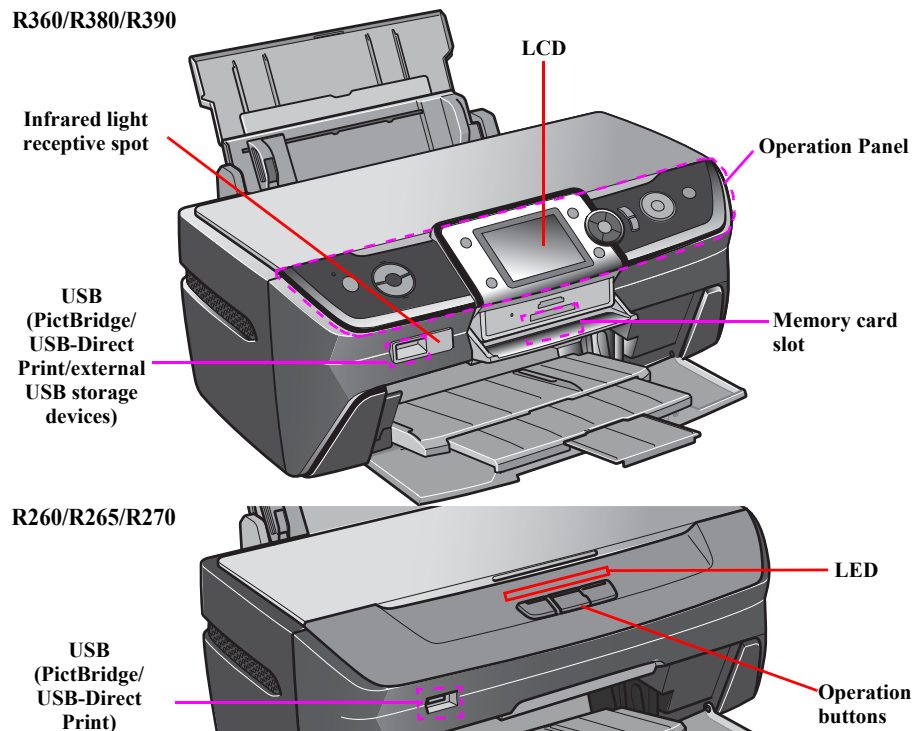

Figure 1-1. Difference in Appearance

Functional differences

Table 1-1. List of Functional Differences

Function		R360/380/390	R260/265/270
Color LCD		√	-
Connection with USB devices	DSC	√	√
	USB storage device	√	-
Memory card slot		√	-
Printing on CDs/DVDs without a PC		√	-
Printing frames of a movie file		√	-
Memory card backup		√	-
USB-Direct Print/PictBridge		√	√

1.2 Basic Specifications

1.2.1 Printing

Basic Specifications

Table 1-2. Basic Specifications

Item	Description
Print method	On-demand inkjet printer
Print head	Black ink: 90 nozzles Color ink: 90 nozzles x 5 colors (C, M, Y, LC, LM)
Printing direction	Bi-directional shortest-distance printing with logic seeking
Resolution	5760 x 1440 dpi at max.
Input buffer	64K bytes

Printhead

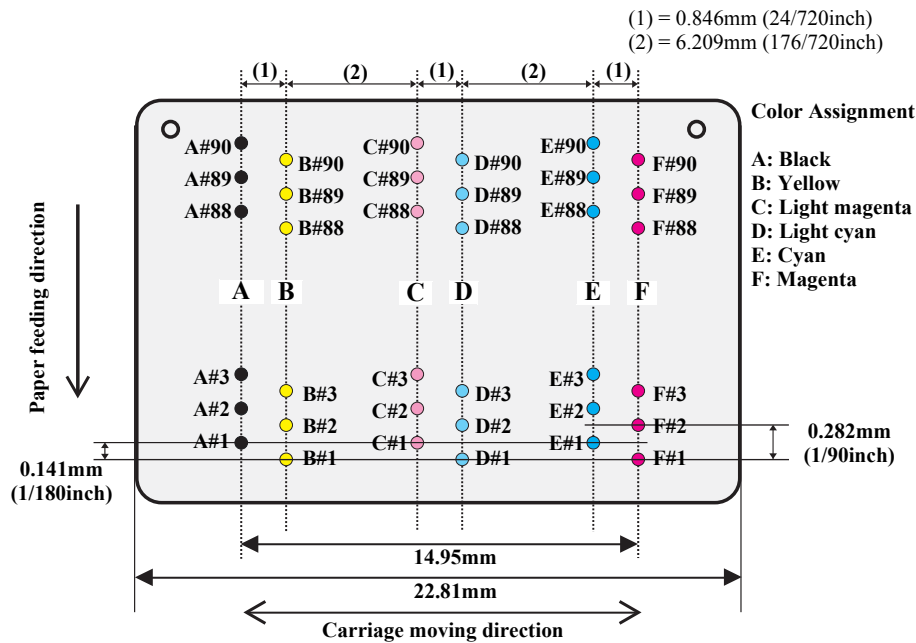

Figure 1-2. Nozzle Configuration

Paper Feeding

Table 1-3. Paper Feeding Specifications

Item	Description
Paper feed method	Friction feed with ASF (Auto Sheet Feeder)
Feed path	Feeds from the top and ejects from the front
Feed speed (25.4mm feed)	R360/380/390: 230.91 mm/sec (9.1 inch/sec) R260/265/270: 110.00 mm/sec (4.3 inch/sec)
Line pitch	Programmable in units of 0.0176mm (1/1440inch)

Functions to prevent direct print on the platen

Table 1-4. Platen Print Prevention Functions

Print mode	Function
Borderless print	The prevention function works according to a detected paper top and width.
Print with margins	The prevention function works according to a paper width detected when printing the 1st page of the 1st job.
Economy print mode	The prevention function does not work.

1.2.2 Interfaces

The printers are equipped with the following interfaces.

- USB I/F
 - USB DEVICE (for connecting a PC)
 - USB HOST *1 (for connecting a DSC or USB storage device, or for wireless printing using a Bluetooth adaptor (option))
- Memory card slot*2 (multi-slot)
- Infrared port *2
(for infrared communication with a device such as a cellular phone)

NOTE *1: Stylus Photo R260/265/270 supports DSC only.

*2: Stylus Photo R360/380/390 only.



Supported external USB storage devices and Bluetooth adaptors, and devices available for the infrared communication can be checked on Epson website.

1.2.2.1 USB Interface

USB Device Port

Table 1-5. USB Device Port Specifications

Item	Description
Standard	Universal Serial Bus Specifications Revision 2.0 Universal Serial Bus Device Class Definition for Printing Devices Version 1.1
Transfer rate	480Mbps (High Speed Device)
Data format	NRZI
Connector type	USB Series B
Recommended cable length	2 meters or shorter

USB Host Port

Table 1-6. USB Host Port Specifications

Item	Description
Standard	Universal Serial Bus Specifications Revision 2.0 Universal Serial Bus Mass Storage Class Bulk-Only Transport Revision 1.0** (R360/380/390 only)
Transfer rate	480Mbps (High Speed Device)
Data format	NRZI
Connector type	USB Series A
Recommended cable length	2 meters or shorter

1.2.2.2 Infrared Port (R360/R380/R390 only)

Table 1-7. Infrared Port Specifications

Item	Description
Communication standard	Conforms to IrDA ver.1.3 (Low Power) and other IrDA communication standards
Communication speed	9.6kbit/s - 115.2kbit/s, 0.576Mbit/s, 1.152Mbit/s, 4.0Mbit/s
Communication distance	0 to 20cm (with no obstructions)
Supported object data type	<ul style="list-style-type: none"> • JPEG • vNote • vCard • vCalendar • vMessage

1.2.2.3 Memory Card Slot (R360/R380/R390 only)

Table 1-8. Compatible Card Types by the Card Slot

Priority	Slot	Compatible Card Type	Standard	Remarks
1	CF Type II	Compact Flash	CF+ and CompactFlash Specification Revision 2.0 compliant	Memory card only
		Microdrive		
2	xD-Picture card	xD-Picture card	xD-Picture Card Specification Version 1.20 compliant	Supports Type M/H
3	Memory Stick/ Memory Stick PRO	Memory Stick	MemoryStick Standard version 1.40-00 compliant	max: 128MB Includes Memory Stick with memory selection function.
		MagicGate Memory Stick		Copyright protection function is not supported.
		Memory Stick PRO	MemoryStick Standard Memory Stick PRO Format Specifications version 1.01-00 compliant	Copyright protection function is not supported.
		Memory Stick Duo/Pro Duo		An adaptor is required.
	SD/MMC	SD	SD Memory Card Specifications / PART1. Physical Layer Specification Version 2.0 compliant	
		miniSD/microSD		An adaptor is required.
		SDHC		Speed Class is not supported.
		miniSDHC/microSDHC		An adaptor is required. Speed Class is not supported.
	MMC	MultiMediaCard System Specification Version 3.31 compliant		

Note : Only one medium is accessible at a time either from the printer or a PC. When multiple media are detected at power-on, the printer accesses one by one in the predetermined order given in the priority column. When a medium in an enabled slot is removed, the next priority slot becomes enabled if a medium is in the slot. Reinserting the medium in the next priority slot is not required. If no media is detected, the CF slot becomes enabled. Removing/reinserting media in disabled slots does not affect the access priority.

When a target medium does not become accessible because of another medium inserted in a slot that has higher priority than the target one, remove the another medium in order to enable the target slot.

Notes on handling memory card by access method

When accessing media from the printer:

Frame numbers are automatically assigned to image files in an accessible medium. The total number of image files does not change if another medium is inserted into a disabled slot.

When accessing media from a Windows PC:

One removal disk drive is displayed even when multiple media are inserted into the printer slots. A medium in an enabled slot is accessed from the "removal disk drive".

When accessing media from a Macintosh PC:

A medium in an enabled slot is mounted on the desktop. Another medium inserted in a disabled slot is not mounted.

1.3 Standalone Printing (R360/R380/R390 only)

The Stylus Photo R360/R380/R390 offers Direct-Print function that allows the user to print directly from a memory card without using a PC. Besides printing still images, printing frames of a movie file is also available. The Memory Card button on the operation panel displays menus for printing both still and movie images.

1.3.1 Direct Print of Still Images

File System

Files that conform to DCF Version 1.0 or 2.0 can be used by the standalone print function of this printer. Compatibility of other file systems is not guaranteed. Compatibility of file systems available with the card reader function depends on the host specification.

NOTE: For the detailed specification of DCF, see “Camera File System Standard DCF Version 2.0, JEIDA-CP-3461”

Media Format

- DCF Version 1.0 or 2.0 compliant format.
- DOS FAT format (FAT12/FAT16/FAT32*¹) with single partition (basic partition)
- CD-R media: ISO9660(Joliet) format
- DVD media: ISO9660(Joliet) or ISO9660(Joliet)&UDF bridge format*²

NOTE *1: FAT32 is permitted for media allowed to be used by corresponding memory card standards.

***2:** UDF-formatted DVDs are not supported.

File Type

File types available for the standalone print are as follows:

- JPEG file (*.JPG)
A photo data file that conforms to Exif Version 2.21 (Exif version 1.0/2.0/2.1/2.2/2.21 are supported)
- TIFF file (*.TIF)
An uncompressed RGB photo data file that conforms to Exif Version 2.21 (Exif ver. 1.0/2.0/2.1/2.2/2.21 are supported)
- Camera specification file (*.MRK)
A definition file required when printing using settings made on a camera. “AUTPRINT.MRK” file that has a full pathname of up to 32 characters is valid.

- PRINT Image Framer (P.I.F.) file (*.USD)
A file that contains layout information that conforms to PRINT Image Framer Rev.2.1. Only files in the “¥EPUDL¥” directory are valid.
- PRINT Image Framer (P.I.F.) file (*.FD2)
A file that contains layout information that conforms to PRINT Image Framer Rev.3.1. The printer recognizes the file in a medium regardless of the directly in which the file exists. This file is classified into two styles; template style and complete style.
 - Template style
Defines frame data to be combined with images that can be specified at the time of printing.
 - Complete style
Defines completed layout data that contains images and frames.

NOTE: This product supports up to P.I.F. Rev.3 level 1.



Files saved in the directory (or its sub directory) listed below are not supported for printing.

- Hidden or System folder
- “RECYCLED” folder
- “PREVIEW” folder (stores thumbnails in CASIO DSCs)
- “SCENE”: folder (stores data for best-shot function in CASIO DSCs)
- “MSSONY”: folder (stores e-mail images, voices, movies, or uncompressed images in SONY DSCs)
- “DCIM¥ALBUM¥IMAGE”: folder (stores data for album function in CASIO DSCs)

Valid Image Sizes

Available image sizes for stand-alone print are as follows:

- Horizontal: $80 \leq X \leq 9200$ (pixel)
- Vertical: $80 \leq Y \leq 9200$ (pixel)

Maximum Number of Photo Data Files

The printer can handle up to 999 photo data files in a single memory card. If the number of files stored in a card exceeds the limit, first detected 999 files become valid and others are ignored displaying the total number of files as 999. (1 to 999th photo files are printed when Print All or index print is selected.) Since the file detecting order changes depending on how the files are stored (folder hierarchy or other factors), it is

not guaranteed which files are selected when the number of files is 1000 or more. When photo data files to which a camera has assigned numbers over 999 are specified to be printed, they can be printed unless the total number of files exceeds 999.

File Sort

The printer sorts all the photo data files in a memory card using their full pathnames (such as “\DCIM\100EPSON\EPSN0000.JPG”) and assigns numbers to them. Because the number assignment rule is specific to the printer, the numbers assigned by the printer do not necessarily match the numbers assigned by a camera.

File Sort Rule

The printer sorts photo data files by their full pathnames in ASCII order.

NOTE: *The sorting may fail or be completed improperly if multiple same full pathnames exist. (the existence is not allowed under normal MS-DOS environment.)*

Date Data Acquisition

The printer acquires the date and time data of each photo data file according to the priority list given below.

1. From a digital camera. Acquires date and time data conforms to digital camera standard format (Exif).
2. From a PC or other external device. Acquires date and time data (timestamp of the file) assigned by the file system compatible with MS-DOS.
3. Fixed date and time (1 January 1980 00:00:00)

Note that the acquired date and time of each photo data file is not necessarily the exact date of shooting the photo. The date and time data can be updated after shooting by digital camera’s calendar setting, post-processing or restoring of the photo data. If the data has been updated, the printer acquires the updated date and time information.

Date Range

The printer can handle the following range of date. If photo data files have date and time information outside the range, the printer cannot sort files correctly.

1 January 1980 00:00:00 to 31 December 2099 23:59:59

Maximum Number of Copies

Up to 99 copies can be set per image unless the total number of copies for each photo print operation exceeds 999.

Image files associated with P.I.F.3 script

When an image file associated with P.I.F.3 script file include a rotation tag, the image is rotated as specified by the tag every time it is printed. If the image is printed with a prestored or imported P.I.F. frame that has not associated with any images, rotation direction of the image may differ from that of an image which has not associated with P.I.F.3 script.

1.3.2 Direct Print of Movie Frames

The user can view a movie in a memory card on the printer LCD and select a desired frame of the movie and print the frame. The following two options (1 frame/12 frames) are provided.

Table 1-9. Movie Print

Printing Options	Function
1 frame printing	<ul style="list-style-type: none"> • When “Movie Enhance” setting is ON, selected one frame and the next two frames are printed. • When “Movie Enhance” setting is OFF, the selected one frame is printed.
12 frames printing	<ul style="list-style-type: none"> • The user is required to select a start frame and an end frame. The printer divides the selected portion of a movie into 12 frames to be printed. • “Movie Enhance” setting cannot be made.

- Supported movie format
Supported movie file types are as follows.
Size of a frame to be printed must be less than 848x480 pixels.
 - Motion Jpeg Quicktime (*.MOV)
 - Motion Jpeg AVI (*.AVI)
 - Mpeg-1 (*.mpg)

1.4 Backup Function (R360/R380/R390 only)

Stylus Photo R360/R380/R390 allows the user to easily make a backup of his/her memory card without using a computer. Furthermore, photos in a backup copy can be printed directly from the printer.

Function summary

- Backup entire data in a medium (CF, Smart Media, Memory Stick, SD, xD-Picture Card).
- Creates a backup folder automatically in the destination medium each time a backup is carried out
- Displays a warning message when data size to be backed up exceeds the destination medium capacity.
- Direct print of the backed up data is available.
- Formats the destination medium when the medium has not been formatted or formatted in an unreadable format. (this does not work for CD-R/DVD-R drives)

Available external devices

- Universal Serial Bus Mass Storage Class Bulk-Only Transport Revision 1.0 compliant with any of the following Subclass code
 - 0x06 (SCSI transparent command set)
 - 0x05 (SFF-8070i command set)
 - 0x02 (SFF-8020i command set)
- USB DIRECT-PRINT compliant Digital Still Camera
- DPS Version 1.0 compliant Digital Still Camera

Available media type

Table 1-10. Available Media Type

External Device	Media Type	Remarks
MO drive	MO <ul style="list-style-type: none"> • 128MB • 230MB • 640MB • 1.3GB 	<ul style="list-style-type: none"> • DOS/Windows-formatted MO is recommended. • Reformatting a pre-formatted MO is impossible. • MOs formatted in an unreadable format such as Macintosh HFS or Windows NTFS are reformatted.
CD-R/RW drive	CD-R <ul style="list-style-type: none"> • 640MB (74min.) • 700MB (80min.) 	<ul style="list-style-type: none"> • CD-RW media cannot be used due to the difference of recording method. • Backup to a CD-R once burned using a device other than the printer is not guaranteed.
DVD-R drive	DVD-R <ul style="list-style-type: none"> • 4.7GB (120min.) 	<ul style="list-style-type: none"> • DVD+R, DVD±RW, DVD-RAM media cannot be used due to the difference of recording method. • Backup to a DVD-R once burned using a device other than the printer is not guaranteed.

CHECK POINT



Each medium can be rewritten only a limited number of times as described below.

- **MO: max. 512 times (001 to 512)**
If any files other than backup folders exist in the route directly, the max. number of writings becomes less than 512 due to the MS-DOS restriction. When more than 512 times of writing history of an inserted MO is detected, the printer handles it as a backup error (file name error, folder hierarchy error).
- **CD-R 640MB max. 47 times**
700MB max. 50 times
The number of writings is limited as shown above because each session information must be saved.
- **DVD-R 4.7GB max. 274 times**
The number of writings is limited as shown above because each session information must be saved.

Writing Format for CD-R Media

Writing to CD-R media is made in multisession type (Model 1) and ISO-9660 (Joliet)-compliant format.

Files or folders whose name includes an unsupported character code or is too long (file/folder name must be less than 8 characters, and the extensions must be less than 3 characters), the names are automatically changed as explained below.

- File name: EPSONXXX.JPG
- Folder name: EPDIRXXX

NOTE 1 : 001-999 numbers are applied to XXX in ascending order.

2 : An unsupported character-code used in the extension is replaced with an underbar.

3 : During a single backup operation, the number of automatic change of file/folder names is limited to 999 times. When it exceeds, no more files/folders that contain an unsupported character-code cannot be backed up.

4 : If a file or folder name that is automatically changed due to an unsupported character code already exists in the medium, the change is cancelled and the file or folder cannot be backed up.

Writing Format for DVD-R Media

Writing to DVD-R media is made in UDF 1.50 (ISO9660 Bridge) format. The file name length and the path length have the following limitations.

- File name length: Max. 255 bytes
- Path length: Max. 1023 bytes

NOTE: Characters available for a folder and file name are capital alphanumeric and underbars. Characters other than those are replaced with underbars.

**CHECK
POINT**



A memory card that has 8-level or more hierarchy of directories cannot be backed up to both a CD-R and DVD-R.

Operation After Backup to CD-R/DVD-R Media

The CD-R/DVD-R is automatically ejected from the external device.

Backup Restrictions

- Browsing an external device from a PC cannot be made.
- The printer and an external device must be directly connected with a USB cable. Connection via a HUB is not supported.
- A connection with a PC must have been disconnected before starting a backup in order to establish exclusive access over the medium to be backed up. There is no need to physically disconnect the PC (disconnect the USB cable).
- Partitioned media cannot be used for backup.
- Writing backup data stored in a medium back to a memory card or other media cannot be made because it may destroy the data in a DSC.
- Since the printer does not have calendar function, created date and time of backup files is the date and time initially assigned or updated by a device other than the printer.

Backup-related errors

Table 1-11. Backup-related Errors

Error	Description	Message	Remedy
Backup error (no external connection)	No external device is detected when a backup is attempted.	External device is not connected or media is not inserted. Backup canceled.	Connect an external device.
Backup error (insufficient external media capacity)	Free space of the destination medium in the external device is not enough to save the data.	Insufficient space on the backup device. Cannot back up files.	Replace the medium with a one that has enough space.
Backup error (no card)	No memory card is detected when backing up memory card is attempted.	No memory card in slot. Backup canceled.	Insert a memory card.
Backup error (connecting to PC)	Backing up memory card is attempted when a PC is connected.	Disconnect from PC before backing up files.	Disconnect the connection with the PC.

Backup error

A hexadecimal 8-digit error code appears below the message; “Backup canceled” when a backup error occurs.

The leftmost 2-digit shows an error code controlled by the printer firmware. See [Table 1-12. Backup Error FW Control Code List](#) on the next page to identify the error cause shown by the 2-digit error code.

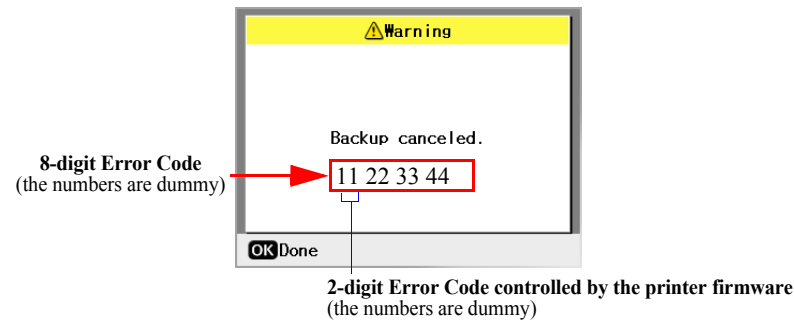

Figure 1-3. Backup Error Message and Error Code

The table below lists the error codes controlled by the printer firmware.

Table 1-12. Backup Error FW Control Code List

Code	Meaning	Code	Meaning
0x00	No error	0xC0	No files to be backed up
0x10	Album function error	0xE7	Parameter error
0x20	Backup function error	0xE8	File open error
0xA0	Other ATAPI/SCSI command error	0xE9	Internal buffer overflow
0xA1	ModeSense command error	0xEA	CD/DVD format error
0xA2	ModeSelect command error	0xEB	Not used
0xA3	Get Disc Information command error	0xEC	Insufficient memory
0xA4	Get Track Information command error	0xED	Some data exist in the destination directory
0xA5	Synchronize Cache command error	0xEE	Not used
0xA6	CloseSession command error	0xEF	Write-protect error
0xA7	Read command error	0xF0	Read/write error
0xA8	Write command error	0xF1	Invalid file open mode
0xA9	Set Speed command error	0xF2	Seek error
0xAA	Eject command error	0xF3	Overflow of root directory
0xAB	Drive lock command error	0xF4	Overflow of file descriptor
0xAC	GetConfiguration command error	0xF5	Invalid path name
0xAD	Verify command error	0xF6	No file exist
0xAE	Device error	0xF7	Medium was exchanged
0xB8	Short file name convert error	0xF8	Unformatted medium
0xB9	Unsupported device	0xF9	Device is not ready
0xBA	No medium	0xFA	Invalid device handle
0xBB	Not writable medium	0xFB	Invalid file descriptor
0xBC	Unsupported medium	0xFC	Not used
0xBD	Hierarchical directory error	0xFD	Backup initialization failed
0xBE	Path length is too long	0xFE	Acquiring memory pool failed
0xBF	File name is too long	0xFF	System error

1.5 CD/DVD Print (R360/R380/R390 only)

Stylus Photo R360/R380/R390 provides the Print CD/DVD button that allows the user to easily access the menus for printing on CDs/DVDs and their jackets. The menus include the following layout options. The user can select one of the layouts and choose photos up to 12 in a memory card to be printed.

- 4 layouts for CD/DVD label printing
- 2 layouts for CD/DVD jacket printing on A4 sized paper

NOTE: *The Stylus Photo R260/R265/R270 do not provide the standalone CDs/DVDs print function. To print directly on CDs/DVDs with those models, the print setting must be made on a PC and sent to the printer.*

1.6 Operation Panel

1.6.1 Operation Panel

Appearance of the operation panels are shown below.

Stylus Photo R360/R380/R390 Operation Panel

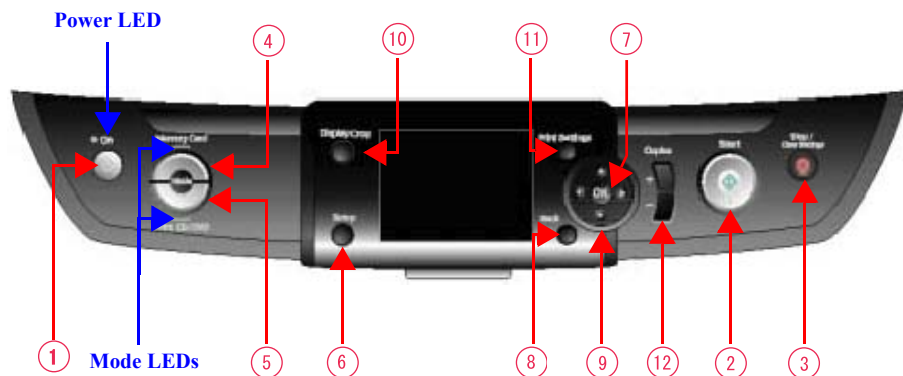

Figure 1-4. Stylus Photo R360//R380/R390

NOTE: The operation panel shown above is that of a model for EAI. The location and functions of the buttons and LEDs, however, do not differ by destination.

Table 1-13. R360/R380/R390 Button Functions

Button	Function
5 Print CD/DVD	Displays the menu to print directly on CDs/DVDs, or jackets for them.
6 Setup	Displays various setup menus such as maintenance menus (Change Ink Cartridge, Head Cleaning, Nozzle Check, etc.), Backup Memory Card menu and option setting menus (Bluetooth settings, etc.).
7 OK	Accepts the selection or changed settings.
8 Back	Undoes the last action made by the operation panel.
9 Cross key (left/right/up/down)	Selects a menu item or setting.
10 Display/Crop	Sets scale of enlargement of an image. Switches the display between an image and image information and 16-thumbnail view.
11 Print Settings	Displays a print setting menu such as layout, print density according to the currently selected mode.
12 Copies (+/-)	Increases/decreases the number of copies.

Table 1-13. R360/R380/R390 Button Functions

Button	Function
1 Power	Turns the printer On or Off.
2 Start	Starts printing.
3 Stop	<ul style="list-style-type: none"> At standalone printing, cancels the operation and returns to the menu. When performing a print job sent from a PC, cancels the job and ejects paper. In cases other than above, returns the current print settings to their factory default and displays the top menu screen of the current mode. (When pressed during printing, returns to the previous menu screen without resetting the settings.)
4 Memory Card	Displays the menu to print photos/movies stored in a memory card.

Stylus Photo R260/R265/R270 Operation Panel

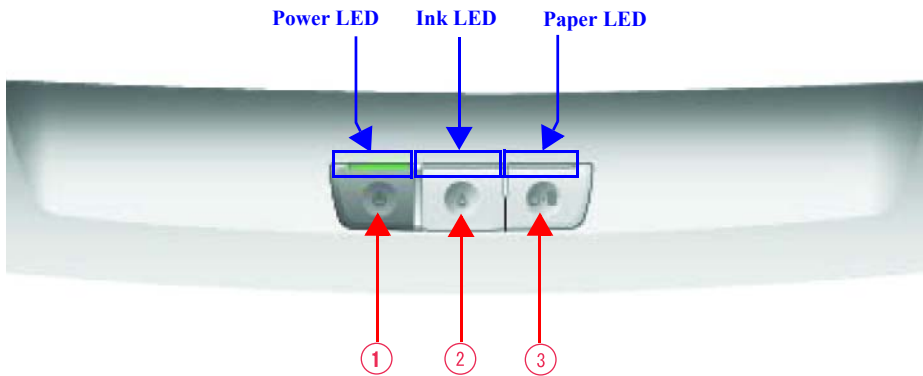

Figure 1-5. Stylus Photo R260/R265/R270

Table 1-14. R260/R265/R270 Button Functions

Button	Function
1 Power	Turns the printer On or Off.
2 Ink	Carries out ink cartridge replacement sequence, or runs a cleaning.
3 Paper	Feeds/ejects paper.

1.6.2 Indicator (LED)

Stylus Photo R360/R380/R390

These models are equipped with a 3.5inch color LCD (320x240) and one Power LED and two Mode LEDs on their control panel. The LCD displays menus for selecting function, making settings, and a status of the printer.

- **Power LED** (green):
Lights during the printer is powered. Flashes when printing or other operations are in progress.
- **Mode LEDs** (green):
Lights while the corresponding mode is selected.
- **Card LED** (green):
Located beside the memory card slots. Kept on while a memory card is in the slot, and flashes while the card being accessed.

Stylus Photo R260/R265/R270

Three LEDs; power, ink, paper are provided.

- **Power LED** (green):
Lights during the printer is powered. Flashes when printing or other operations are in progress.
- **Ink LED** (red) / **Paper LED** (red):
Lights or flashes when an error occurs.



Refer to [Chapter 3 Troubleshooting](#) for details on the LCD/LED displays.

1.7 Specifications Common to the Models

1.7.1 Electric Specifications

Table 1-15. Electric Specifications

Item	100-120V model	220-240V model
Rated voltage	100-120 VAC	220-240 VAC
Input voltage range	90 - 132 VAC	198-264 VAC
Rated current	0.6 A R260/265/270: max. 0.9A R360/380/390: max. 1.1A	0.3 A (max. 0.5A)
Rated frequency	50 - 60 Hz	
Input frequency range	49.5 - 60.5 Hz	
Dielectric strength	R260/265/270: 3000 V for 1 minute R360/380/390: AC 1000 Vrms for 1 min., AC 1200 Vrms for 1 sec.	
Energy conservation	Energy Star compliant	
Safety standard	UL60950 CSA22.2 No.60950	EN60950
EMC	FCC part 15 subpart B Class B CAN/CSA-CEI/IEC CISPR 22 Class B	EN 55022 (CISPR Pub.22) Class B EN 61000-3-2 EN 61000-3-3 EN 55024 AS/NZS CISPR22 Class B

Table 1-16. Power Consumption

Printer status	Model Name	100-120V model	220-240V model
Printing*1	R260/R265/R270	Approx. 12W	
	R360/R380/R390	Approx. 17W	
Sleep mode	R260/R265/R270	Approx. 1.1W	Approx. 1.2W
	R360/R380/R390	Approx. 4.5W	Approx. 5.0W
Power off mode	R260/R265/R270	Approx. 0.2W	Approx. 0.4W
	R360/R380/R390		

Note : When the printer is kept idle for 3 minutes, it goes into standby mode that saves current to the motors.

Note *1: When performing a print job sent from a PC. Printing Letter Pattern on A4 sized plain paper (the test conforms to ISO/IEC10561).

1.7.2 Environmental Condition

Table 1-17. Environmental Condition

Item	Operating	Storage*2
Temperature*1	10 to 35 °C	-20 to 40 °C*3
Humidity (no condensation)*1	20 to 80%, RH	5 to 85%, RH
Impact resistance	1 G, 1 x 10 ⁻³ seconds	2 G, 2 x 10 ⁻³ seconds
Vibration resistance	0.15G	0.50G

Note *1: Must be within the range shown in Fig.1-6.

*2: Non-operating with unpacked.

*3: Must be less than 1 month at temperature 40 °C.

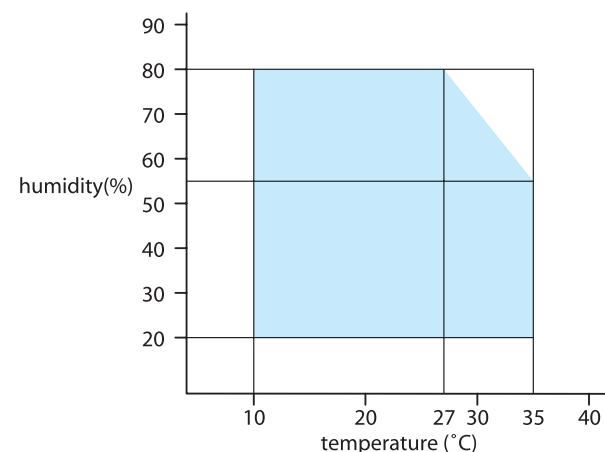

Figure 1-6. Temperature/Humidity Range

1.7.3 Durability

- Printer: 16,000 pages (A4/Letter) or 5 years whichever is faster
- Printhead: 6 billion shots per nozzle or 5 years whichever is faster

1.7.4 Noise Level

- R260/R265/R270: Approx. 42 dB (when copying according to ISO7779)
- R360/R380/R390: Max. 42 dB (during standalone printing according to ISO7779)

1.7.5 Dimensions

Table 1-18. Dimensions

Item		R260/R265/R270	R360/R380/R390
Weight		6.2 kg	6.6 kg
Dimensions (W x D x H)	With covers closed	453 x 337 x 194 mm	453 x 343 x 194 mm
	With covers opened	453 x 538 x 285 mm	450 x 538 x 285 mm

CHAPTER

2

OPERATING PRINCIPLES

2.1 Overview

This chapter describes the operating principles of the printer mechanism and electric circuit boards of Stylus Photo R260/R265/R270 and R360/R380/R390.

2.1.1 Printer Mechanism

The main components of the printer mechanism are shown in the table below.

Table 2-1. Printer Mechanism Main Components

Component	Function
CR Unit	Moves along the CR shaft to print on paper being powered by the CR motor. The unit includes Printhead, PW sensor, and CR encoder sensor.
APG Unit	Moves the carriage upward/downward to adjust the platen gap being powered by the PF motor. There are 4 preset levels of platen gap and the unit moves the carriage to one of the levels according to the current carriage position detected by the APG sensor.
PF Unit	Rotates the PF roller shaft to feed paper being powered by the PF motor.
ASF Unit	Being powered by the PF motor, feeds paper loaded on the ASF into the printer mechanism.
EJ Unit	Being powered by the PF motor, ejects paper or the CDR tray. The EJ frame moves upward/downward corresponding to the stacker that can be moved manually so that the frame matches with the paper size.
Ink System	Located on the right side of the printer mechanism. Covers the printhead with the cap holder when the printhead is not used, and draws waste ink out of the printhead. The waste ink is sent to the Waste Ink Tray through the waste ink tube.

The main control boards are shown in the table below.

Table 2-2. Main Control Boards

Board	Function
Main Board	Located on top of the printer mechanism and controls all over the printer operations.
Power Supply Board (P/S ASSY)	Located on the Lower Housing and generates required voltages for the printer using the power supplied from the AC power line.
Panel Board	Located inside the Panel Unit and controls the operation panel including the LCD. (R360/R380/R390 are equipped with a LCD.)

Table 2-2. Main Control Boards

Board	Function
Card Board (R360/R380/R390 only)	Located on the Middle Housing. Incorporates memory card slots, USB HOST interface, and an infrared communication circuit.
USB Board (R260/R265/R270 only)	Located on the Middle Housing. Incorporates a USB HOST interface.

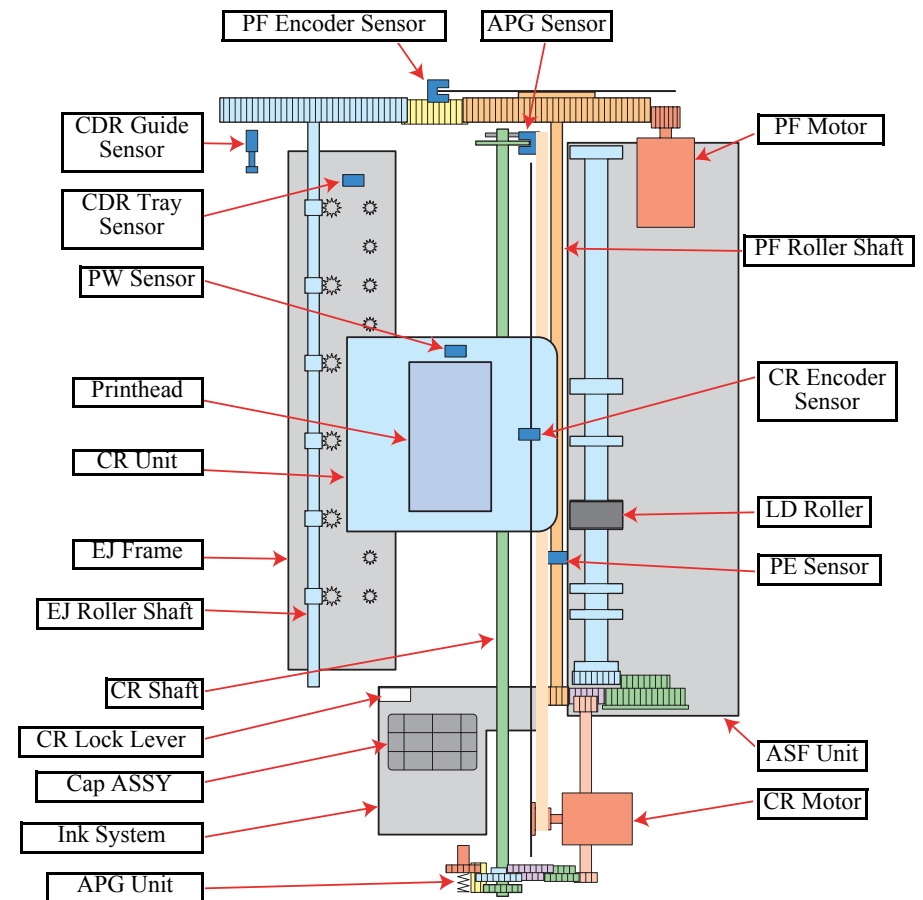

Figure 2-1. Printer Mechanism Diagram

2.1.2 Motors & Sensors

Table 2-3. List of Motors & Sensors

No.	Motor/Sensor Name	Function
1	Printhead	F3-MACH head (6 colors x 90 nozzles)
2	CR motor	Type: DC motor Drive voltage: 42V DC \pm 5% (voltage applied to the driver) Coil resistance: 22.7 Ω \pm 10% Inductance: 17.5mH \pm 25% Drive method: PWM constant-current chopping
3	PF motor	Type: DC motor Drive voltage: 42V DC \pm 5% (voltage applied to the driver) Coil resistance: 21.2 Ω \pm 10% Inductance: 17.2mH (1 kHz) Drive method: PWM
4	PE sensor	Detecting items: paper end, leading edge of paper Type: Transmissive photo interrupter
5	Ink cartridge detector	CSIC
6	PTS sensor (CR)	Type: Transmissive photo interrupter Resolution: 180 pulse/inch
7	PTS sensor (PF)	Type: Transmissive photo interrupter Resolution: 180 pulse/inch
8	PW sensor	Detecting items: • Left/right edges of paper (before/during printing) • Top edge of paper (before printing) • Bottom edge of paper (during printing) • Left/right/top/bottom of CDR (before printing) Type: Reflective photo interrupter
9	APG sensor	Detecting items: APG position Type: Transmissive photo interrupter
10	CDR Guide sensor	Detecting items: Up/Down status of the CDR Guide Type: Mechanical contact
11	CDR Tray sensor	Detecting items: Presence of CDR tray Type: Mechanical contact

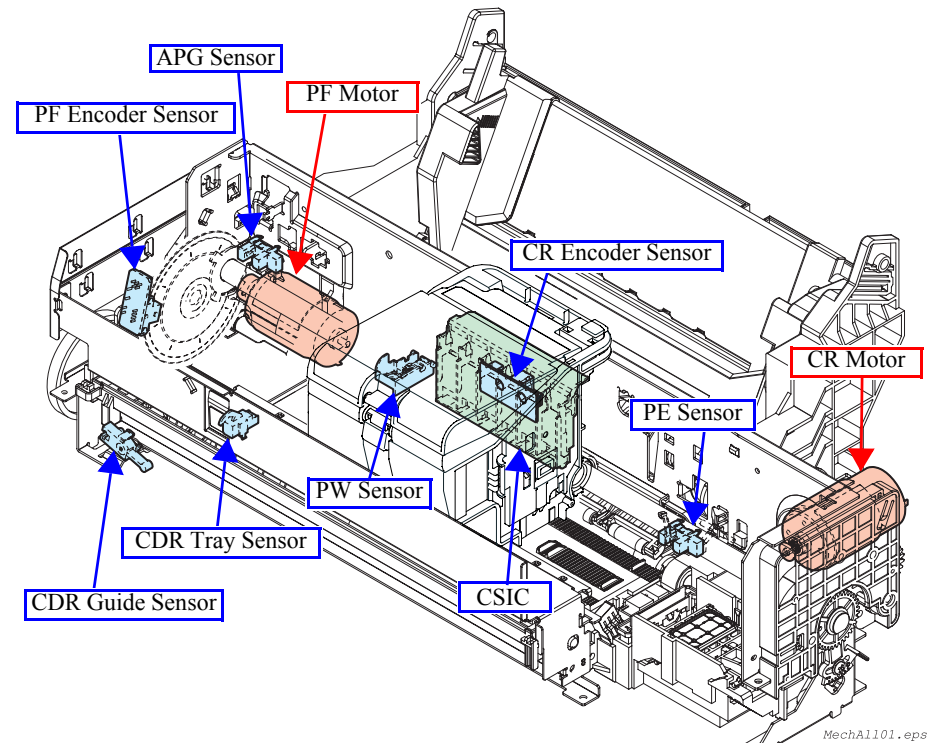

Figure 2-2. Motors & Sensors in the Printer Mechanism

2.2 Electrical Circuit Operating Principles

The electric circuits of the Stylus Photo R260/R265/R270 and R360/R380/R390 consist of the following boards.

Table 2-4. Main Boards & Model Numbers

Board Name	R360/R380/R390	R/260/R265/R270
Main Board	C658MAIN	C653MAIN
Power Supply Board	C653PSB	
Panel Board	C658PNL + C658PNL-B	C653PNL
Card Board	C658STG	Not equipped
USB Board	Not equipped	C653IF

2.2.1 Main Features

- Features common to R260/R265/R270 and R360/R380/R390
 - The circuits support multi-common printing method that achieves high-speed printing reducing the number of carriage movements.
- Features of C658Main Board (R360/R380/R390)
 - The CPU incorporates an ASIC for controlling memory cards. The ASIC achieves high-speed access to a card.
 - Employs SOC06H that incorporates one main processor and six image processing processors enabling concurrent processing for printing.
 - 16-bit DDR1-SDRAM (166 MHz) memory for image processing on the local side enables a wide range of memory access.
 - 72 MHz SDRAM is on the CPU bus as a system memory enabling a wide range of memory access.
 - By employing a self-powered motor driver, the cost for supplying power to the RTC (5V) and USB HostVCC (6V), and for motor drive circuit are reduced.
 - UBEC (Ultra Block Encode) allows MW buffer size to be reduced to one third the conventional size.
 - Equips a 3.5inch Color TFT LCD as standard.
- Features of C653Main Board (R260/R265/R270)
 - The newly employed SOC achieves throughput enhancement. The incorporated USB host function offers USB host High Speed compatibility.
- Operations to reduce power consumption

The printer carries out the following operations to go into sleep mode.

 - Decreases the power voltage
 - Shuts off photoelectric current of photo interrupter sensors.
 - Stops the motor drive circuit.
 - Stops the UDL clock in the ASIC.
 - De-energizes the motors
 - Stops the head drive circuit
 - High-efficiency power supply circuit (R360/R380/R390 only)
 - Goes into CPU core low-power consumption mode (R360/R380/R390 only)
 - Cuts power for the preview monitor (R360/R380/R390 only)
 - Goes into SDRAM self-refresh mode (R260/R265/R270 only)

2.2.2 Components of Control Boards

Table 2-5. Components of Control Boards

Board Name		Incorporated Components	
		R360/R380/R390	R260/R265/R270
Main Board	System	<input type="checkbox"/> Logic circuit (ASIC incorporated in the CPU core, Flash ROM x 2, SDRAM x 1, DDR1 x 1)	<input type="checkbox"/> Logic circuit (ASIC incorporated in the CPU core, Flash ROM x 1, SDRAM x 1)
		<input type="checkbox"/> Interface circuit (USB2.0 DEVICE, USB2.0 HOST) <input type="checkbox"/> RTC circuit <input type="checkbox"/> Panel interface	
		<input type="checkbox"/> 3.5-inch Color LCD interface <input type="checkbox"/> IrDA circuit	Not equipped
	Power supply	<input type="checkbox"/> Regulator circuit <input type="checkbox"/> Power switch circuit <input type="checkbox"/> Overvoltage protection circuit <input type="checkbox"/> ASIC for control	
	Printer	<input type="checkbox"/> Motor control/drive circuit (PF, CR, APG) <input type="checkbox"/> Printhead control/drive circuit <input type="checkbox"/> Sensor circuits (PE, PF, PW, APG, CDR Guide, CDR Tray)	
Card Board		<input type="checkbox"/> Logic circuit (card control IC) <input type="checkbox"/> USB HOST I/F circuit <input type="checkbox"/> IrDA I/F circuit <input type="checkbox"/> Memory card control circuit	Not equipped
USB Board		Not equipped	<input type="checkbox"/> USB HOST I/F circuit
Panel Board		<input type="checkbox"/> Power switch circuit <input type="checkbox"/> Switch circuit <input type="checkbox"/> LED circuit	
LCD Module		<input type="checkbox"/> LCD control circuit <input type="checkbox"/> 3.5-inch Color LCD panel	Not equipped

2.2.3 Circuit Block Diagram

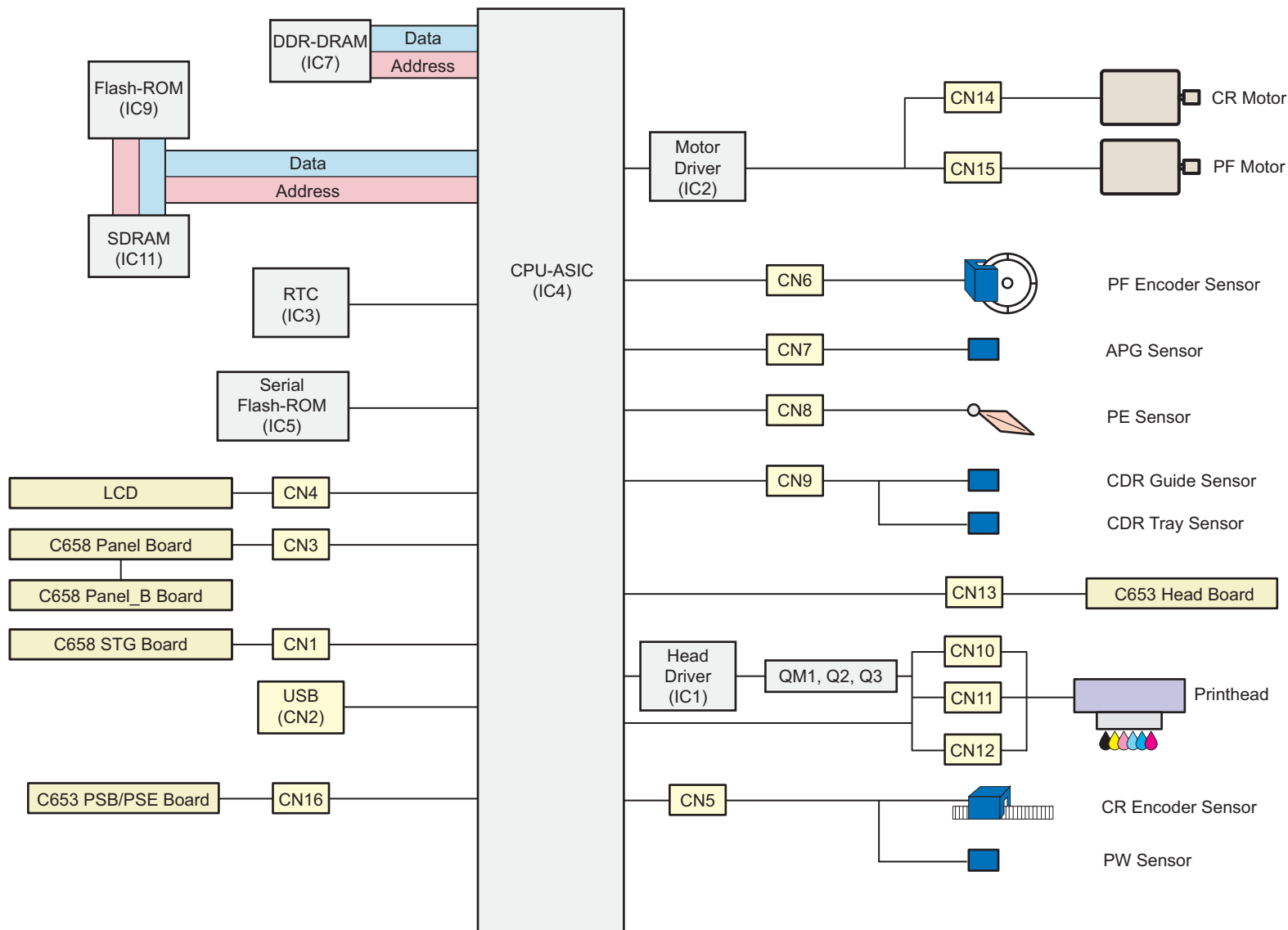

Figure 2-3. Circuit Block Diagram for R360/R380/R390

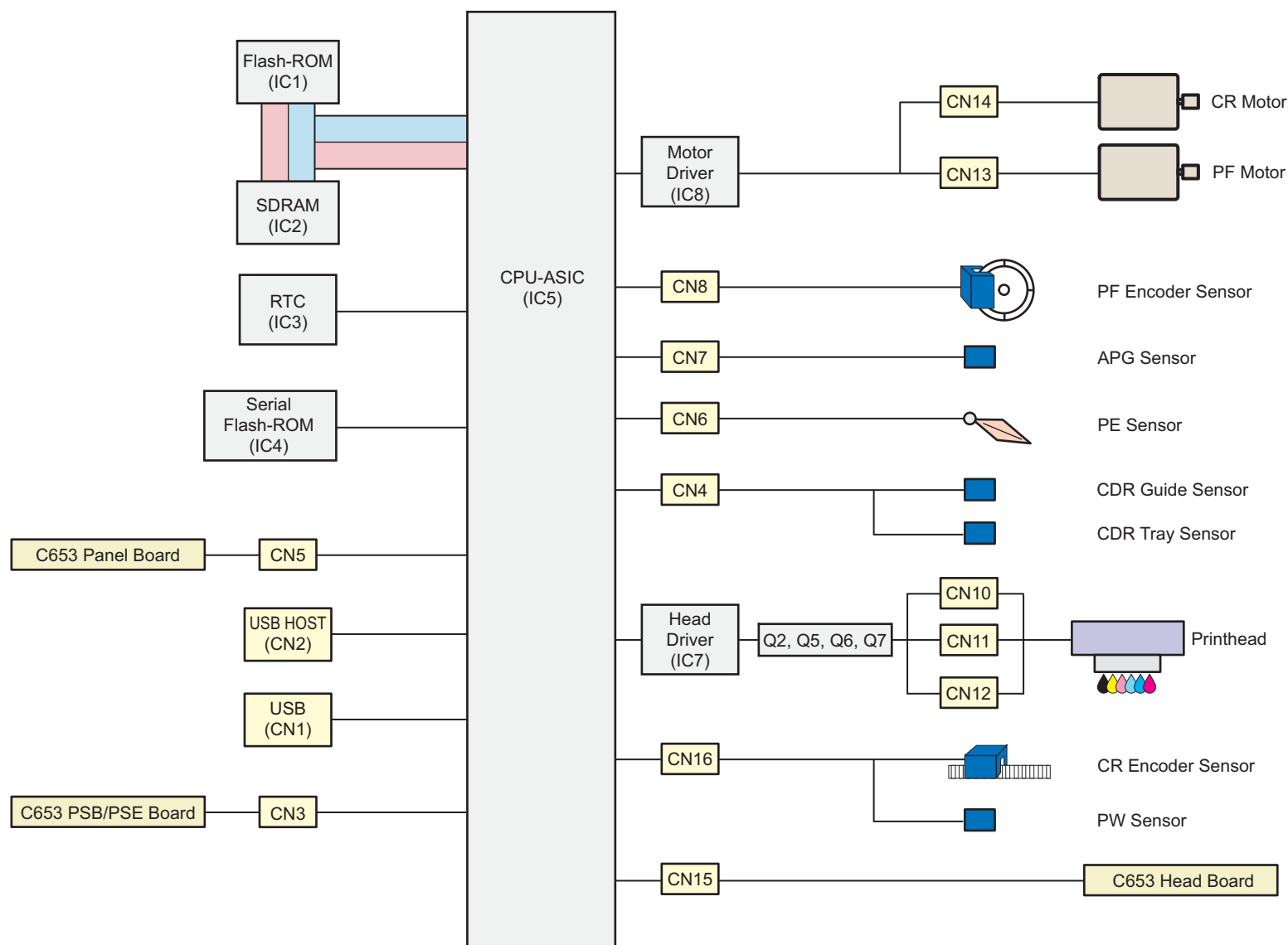

Figure 2-4. Circuit Block Diagram for R260/R265/R270

2.3 Banding Reduction System (BRS) / Paper Feed Amount Profile Correction (PFP)

□ Overview

In order to ensure high print quality and high print speed, this product incorporates the Banding Reduction System (BRS) and Paper Feed Profile (PFP) Correction system. The overview of them is described in the table below.

Table 2-6. Overview of BRS and PFP

	Summary	Target Print Mode			Remarks
		Paper Type	Paper Size	Resolutions (dpi)	
BRS	Conventional models perform overlapping printing (2-path or 4-path print) to reduce banding problem. Printers that incorporate the Banding Reducing System do not perform the overlapping printing. They carry out 1-path printing correcting ink drop amount for each raster mode in order to avoid making a gap between each path (printed line). This enables to achieve both high print quality (less banding) and high print speed.	Ultra Glossy Photo Paper Premium Glossy Photo Paper Glossy Photo Paper Premium Semigloss Photo Paper	4 x 6 inch (102 x 152 mm)	720 x 720	---
PFP	In the conventional method to improve paper feed accuracy, the adjustment value is calculated based on a value obtained at a certain point of paper. Therefore, correcting the total paper feed amount (from when paper is fed and to when finishing printing) was impossible. The Paper Feed Amount Profile Correction offers more precise control over the paper feeding. Paper feed errors are measured at various points and a correction value is calculated for each of the points. This enables to ensure print quality in the target print mode.	Ultra Glossy Photo Paper Premium Glossy Photo Paper Glossy Photo Paper Premium Semigloss Photo Paper	4 x 6 inch (102 x 152 mm)	720 x 720	With BRS, Borderless print
				720 x 360	Without BRS, Borderless print

□ Adjustment/Correction method

Correction values of the BRS and the PFP are automatically calculated when a pattern printed by the printer is scanned by a specified scanner. The created correction values are stored into the serial flash ROM on the main board, and applied when printing in the target print mode.



For information on how to carry out the BRS and PFP, See [Chapter 5 Adjustment](#).

CHAPTER

3

TROUBLESHOOTING

3.1 Overview

This chapter provides how to troubleshoot problems analyzing the cause based on the error messages displayed on the printer and the observed symptom. Identify and troubleshoot the problem referring to the tables on the following pages. When some parts need to be replaced, make sure to follow the procedure given in Chapter 4 and carry out required adjustments. If any abnormality is observed in motors or sensors, check the electrical value referring to the 3.1.1 "Troubleshooting on Motors and Sensors"(p.32).

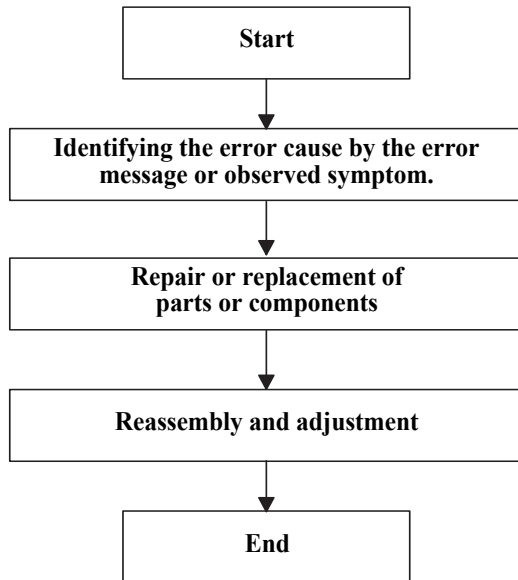

Figure 3-1. Troubleshooting Flowchart

3.1.1 Troubleshooting on Motors and Sensors

The following tables show the normal electric values of each motor and sensor. When any abnormality is observed in motors and sensors, check their electric values and compare them with the values given in the tables to see if the motors or sensors are broken or not.

Table 3-1. Motor Resistance & Measuring Points

Motor	Motor Connector	Measuring Points	Resistance
CR Motor	R360/R380/R390: CN14 R260/R265/R270: CN14	Between Pin 1 and 2	22.7Ω ± 10%
PF Motor	R360/R380/R390: CN15 R260/R265/R270: CN13	Between Pin 1 and 2	21.2Ω ± 10%

Table 3-2. Sensor Checkpoints

Sensor	Sensor Connector	Signal Level	Status
PE Sensor	R360/R380/R390: CN8 R260/R265/R270: CN6 Between Pin 1-2	2.4V or more	No paper
		0.4V or less	Paper exists
APG Sensor	R360/R380/R390: CN7 R260/R265/R270: CN7 Between Pin1- 2	2.4V or more	Within PG position
		0.4V or less	Out of PG position
CDR Guide Sensor	R360/R380/R390: CN9 R260/R265/R270: CN4 Between Pin1- 2	Open: 2.4V or more	CDR Guide lowered
		Close: 0.4V or less	CDR Guide raised
CD-R Tray Sensor	R360/R380/R390: CN9 R260/R265/R270: CN4 Between Pin3- 4	Open: 2.4V or more	CD-R Tray inserted
		Close: 0.4V or less	No CD-R Tray

Note : See 2.1.2 "Motors & Sensors"(p.25) for locations of the motors and sensors.

3.2 Error/Warning Indications

This section describes how the printer indicates an error/warning status with the LCD and LEDs, or on the screen of the printer driver when a problem arises during various operations; power-on sequence, paper feeding, ink drawing, printing, and so on.

3.2.1 Error Indication Method

The Stylus Photo R360/R380/R390 are equipped with a LCD. You can solve most of the troubles following the instructions shown on the LCD or on the windows of “EPSON Status Monitor 3”.

- Stylus Photo R360/R380/R390

Error messages are displayed on the LCD.

- [Figure 1-1. "Difference in Appearance"\(p.9\)](#)

- Stylus Photo R260/R265/R270

Error messages can be checked with the LEDs and on the windows of “EPSON Status Monitor 3”.

- [Figure 1-5. "Stylus Photo R260/R265/R270"\(p.20\)](#)

Table 3-3. LEDs Status (R260/R265/R270)

LED Status	Meaning
--	No change
Light	Lights up normally
Flash	Flashes at intervals of 0.5 seconds.
Flash 2	Flashes as follows; ON (0.2 sec.) - OFF (0.2 sec.) - ON (0.2 sec.) - OFF (0.4 sec.)
Flash 4	Flashes as follows; ON (0.8 sec.) - OFF (0.2 sec.)
High-speed flash	Flashes at intervals of 0.1 seconds.

- Message box on the window of "EPSON Status Monitor 3"

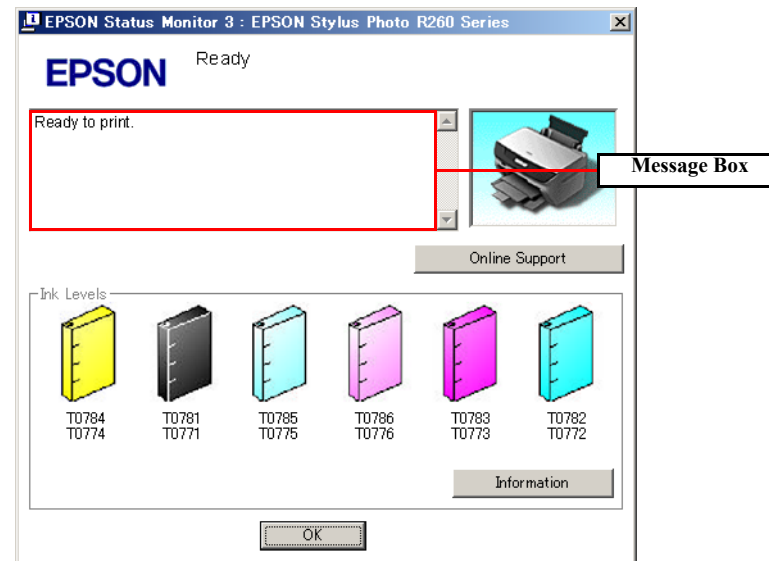

Figure 3-2. Error Indication on EPSON Status Monitor 3

NOTE: The part number of the Ink Cartridges shown in the Status Monitor 3 screen differs by destination.

Table 3-4. List of Error Messages

Error Name	R360/R380/R390	R260/R265/R270			STM3 Message	Error Cause	See the table for Troubleshooting
	Messages on the LCD	LED Indications					
		Power	Paper	Ink			
Communication error	-	-	-	-	Check all connections and make sure all devices are on. If the power was turned off during printing, cancel the print job. If the error does not clear, see your printer documentation.	-	Table 3-5 (p.36)
Maintenance request error	Waste ink pad in the printer is saturated. Contact your dealer to replace it.	Off	Flash (the two LEDs flashes alternately)		Parts inside your printer are at the end of their service life. See your printer documentation.	Some parts in the printer require maintenance such as near-full status of waste ink pad.	-
Fatal error	Printer error. Please see your documentation.	Off	High-speed flash	High-speed flash	Delete all print jobs and turn the printer off. Remove any foreign objects from inside the printer. After a few minutes, turn the printer back on.	An unrecoverable error occurred inside the printer.	Table 3-6 (p.37)
Ink cartridge detection error	Ink cartridges cannot be recognized. Make sure ink cartridges are correctly installed.	-	-	Light	Black: XXXX* Color: XXXX* Epson recommends the genuine Epson cartridges listed above. Click the How to button for ink cartridge replacement instructions.	Ink cartridge is not installed or not installed properly. Or CSIC information cannot be read and written to the printer.	Table 3-7 (p.40)
Ink cover open error	The ink cartridge cover is open. Open the printer cover and close the ink cartridge cover. Press OK to continue.	-	-	Light		The ink change sequence is attempted with the cartridge cover opened.	
Empty cartridge error	Press the OK button to replace the cartridges.	-	-	Light		The cartridge runs out of ink.	
Paper jam	Paper jam. Load paper and press the Start button. If the error does not clear, repeat the procedure.	-	Flash	-	For sheets of paper, turn off the printer and then remove any jammed paper by hand. For a CD or DVD, remove the CD/DVD tray. Next, press the Paper button on the printer or click the Eject button if it appears on this screen.	Paper or CDR tray jammed inside the printer mechanism.	Table 3-8 (p.41)
Multi-feed error	Multi-page feed error. Remove and reload the paper, then press the Start button.	-	Light	-	A page has not been printed, multiple pages have been fed into the printer at once, or the wrong paper size has been fed into the printer. Remove and reload the paper. Press the Paper button if necessary.	Multiple sheets are fed at a time.	

Note *: The “XXXX” represents the part number of the Ink Cartridge.

Table 3-4. List of Error Messages

Error Name	R360/R380/R390	R260/R265/R270			STM3 Message	Error Cause	See the table for Troubleshooting
	Messages on the LCD	LED Indications					
		Power	Paper	Ink			
No paper error	Paper out. Load paper and press the Start button.	-	Light	-	Reload the paper and set the front tray to the paper position by pulling up the tray lever. Then press the Paper button on the printer or click the Continue button if it appears on the screen. To cancel all print jobs, click the Cancel button.	Paper cannot be fed into the printer.	Table 3-9 (p.43)
CDR Tray error	The CD/DVD tray is set incorrectly. Please correct, then press the Start button.	-	Light	-	Reload the tray, then press the Paper button on the printer.	The printer cannot detect the CD/DVD tray properly.	Table 3-10 (p.45)
CDR Guide error	The front tray is in the CD/DVD position. Pull up the tray lever to lower the front tray to the paper position.	-	Flash 2	High-speed flash	For sheets of paper, set the front tray to the paper position by pulling up the tray lever. For a CD or DVD, set the front tray to the CD/DVD position by pushing down the tray lever.	The CDR guide status does not match with the print setting.	Table 3-11 (p.47)
	The front tray is not in the CD/DVD position. Push down the tray lever to raise the front tray to the CD/DVD position.				For sheets of paper, turn off the printer and then remove any jammed paper by hand. For a CD or DVD, remove the CD/DVD tray. Next, press the Paper button on the printer or click the Eject button if it appears on this screen.		
	The CD/DVD guide is in the CD/DVD position. Close the CD/DVD guide.				For sheets of paper, set the front tray to the paper position by pulling up the tray lever. For a CD or DVD, set the front tray to the CD/DVD position by pushing down the tray lever.		

3.3 Troubleshooting by Error Message

The following tables provide troubleshooting procedure for each error message indicated by the LCD or STM3 screen. When some parts need to be replaced or repaired, make sure to follow the procedure given in Chapter 4 and carry out required adjustments.

3.3.1 Troubleshooting Problems with Error Messages

Table 3-5. Troubleshooting for Communication Error

Occurrence Timing	Symptom	Failed Part	Check Point	Remedy	Reference
At power-on	The printer does not work at all.	Panel Board/ Panel FFC	1. Is the Panel FFC not connected to the Panel Board and the Main Board?	1. Connect the FFC correctly. <ul style="list-style-type: none"> ■ R360/R380/R390 Main Board: CN3,CN4 ■ R260/R265/R270 Main Board: CN5 	4.2.6 "Panel Unit"(p.69) / 4.3.5 "Disassembling the Panel Unit"(p.83)
			2. Is the Panel FFC damaged?	2. Replace the Panel FFC.	
			3. Is the Panel Board damaged?	3. Replace the Panel Board.	
		P/S ASSY	1. Is the P/S ASSY connector cable not connected to the Main Board?	1. Connect the cable correctly. <ul style="list-style-type: none"> ■ R360/R380/R390 Main Board: CN16 ■ R260/R265/R270 Main Board: CN3 	4.5.5 "P/S Assy"(p.94)
			2. Is the P/S ASSY cable or the P/S ASSY itself damaged?	2. Replace the P/S ASSY. * If this does not solve the problem, replace the Main Board Assy.	
		USB cable	1. Is the USB cable not connected to the printer and the PC?	1. Connect the USB cable correctly.	-
		Printer driver	1. The printer driver installed on the PC is not the one for the Stylus Photo R360/R380/R390/ R260/R265/R270?	1. Install the correct printer driver.	-
		Main Board	1. The model name written into EEPROM on the Main Board is wrong?	1. Write the correct model name to the EEPROM using the Adjustment Program.	5.1.1 "Servicing Adjustment Item List" (P.113)

Table 3-6. Troubleshooting for Fatal Error

Occurrence Timing	Symptom	Failed Part	Check Point	Remedy	Reference
At power-on	<ul style="list-style-type: none"> • CR motor does not rotate at all. • CR Unit hits against the right side of the Main Frame. 	CR Motor	1. Is the CR motor cable not connected to the Main Board?	1. Connect the cable correctly. <ul style="list-style-type: none"> ■ R360/R380/R390 Main Board: CN14 ■ R260/R265/R270 Main Board: CN14 	4.3.2 "Removing the Main Board Unit"(p.78)
			2. Is there a malfunction of the CR motor?	2. Replace the CR motor.	4.5.8 "CR Motor"(p.99)
		Main Frame	1. Is there any dirt on the Main Frame? Or is the frame not adequately lubricated?	1. Clean off any dirt on the frame and apply adequate grease on it.	6.1.3 "Lubrication" (P.131)
		CR Guide Shaft	1. Is there any dirt on the CR Guide Shaft? Or is the shaft not adequately lubricated?	1. Clean off any dirt on the shaft and apply adequate grease on it.	6.1.3 "Lubrication" (P.131)
			2. Is the PG cam chipped or broken?	2. Replace the CR Guide Shaft.	4.5.12 "CR Unit"(p.105)
		CR Encoder		1. Is the Head FFC not connected to the CR encoder connector?	
				2. Is the CR encoder chipped or broken?	2. Replace the CR Unit.
		Head FFC	1. Is the Head FFC broken?	1. Replace the Head FFC.	
		CR Scale	1. Is the CR Scale not moving freely, centered between the sides of CR encoder sensor?	1. Install the CR Scale correctly.	4.5.1 "CR Scale"(p.89)
			2. Is there any dirt on the CR Scale?	2. Clean off any dirt on the CR Scale. If the scale get heavily soiled, replace the scale.	
3. Is the CR Scale chipped or broken?	3. Replace the CR Scale.				
Timing Belt	1. Is the Timing Belt attached incorrectly?	1. Attach the belt correctly.	4.5.12 "CR Unit"(p.105) / 4.5.8 "CR Motor"(p.99)		

Table 3-6. Troubleshooting for Fatal Error

Occurrence Timing	Symptom	Failed Part	Check Point	Remedy	Reference
At power-on	<ul style="list-style-type: none"> The CR Unit hits against the Change Lever which has come down toward the front of the printer. The error appears after the PF roller makes quick one-turn. 	ASF Unit	1. Is the Compression spring 2.36 of the Change Lever disengaged? 	1. Replace the ASF Unit. For the R360/R380/R390, replace the Change Lever.	4.5.11 "ASF Unit"(p.104)
		PF Motor	1. Is the PF motor cable not connected to the Main Board?	1. Connect the cable to the Main Board. ■ R360/R380/R390 Main Board: CN15 ■ R260/R265/R270 Main Board: CN13	4.3.2 "Removing the Main Board Unit"(p.78)
			2. Is there a malfunction of the PF motor?	2. Replace the PF motor.	4.5.10 "PF Encoder / PF Scale / PF Motor"(p.102)
		PF Encoder	1. Is the PF encoder FFC not connected to the PF encoder connector and the Main Board?	1. Connect the FFC to the PF encoder and the Main Board. ■ PR360/R380/R390 Main Board: CN6 ■ R260/R265/R270 Main Board: CN8	4.3.2 "Removing the Main Board Unit"(p.78) / 4.5.10 "PF Encoder / PF Scale / PF Motor"(p.102)
			2. Is the PF encoder chipped or broken?	2. Replace the PF encoder.	4.5.10 "PF Encoder / PF Scale / PF Motor"(p.102)

Table 3-6. Troubleshooting for Fatal Error

Occurrence Timing	Symptom	Failed Part	Check Point	Remedy	Reference
At power-on	<ul style="list-style-type: none"> The CR Unit hits against the Change Lever which has come down toward the front of the printer. The error appears after the PF roller makes quick one-turn 	PF Scale	1. Is the PF Scale not moving freely, centered between the sides of PF encoder sensor?	1. Install the PF Scale or PF encoder correctly.	4.5.10 "PF Encoder / PF Scale / PF Motor"(p.102)
			2. Is there any dirt on the PF Scale?	2. Clean off any dirt on the PF Scale. If the scale gets heavily soiled, replace the scale.	4.5.10 "PF Encoder / PF Scale / PF Motor"(p.102)
			3. Is the PF Scale chipped or broken?	3. Replace the PF Scale.	
	The CR Unit hits against the Upper Paper Guide detached from the Main Frame.	Upper Paper Guide	1. Is the Upper Paper Guide detached from the Main Frame?	1. Attach the Upper Paper Guide correctly.	4.5.12 "CR Unit"(p.105)
At power-on During changing the platen gap	The error occurs when the PG (gap between the printhead surface and the platen) is changed with the APG Unit.	APG Unit	1. Is the APG Unit installed incorrectly?	1. Install the APG Unit carefully so as not to shift the phase.	4.5.2 "APG Unit"(p.90)
			2. Is the Combination Gear 10,15.2 disengaged or attached incorrectly?	2. Attach the gear correctly.	
					
		APG Sensor Assy	1. Is the APG sensor damaged?	1. Replace the APG Sensor Assy.	4.5.14 "Front Paper Guide Assy/APG Sensor Assy"(p.109)
Any time	Other than above symptoms	Printhead	1. Is the Printhead damaged?	1. Replace the Printhead.	4.5.3 "Printhead"(p.91)
		Main Board	1. Is the Main Board damaged?	1. Replace the Main Board.	4.3.2 "Removing the Main Board Unit"(p.78)

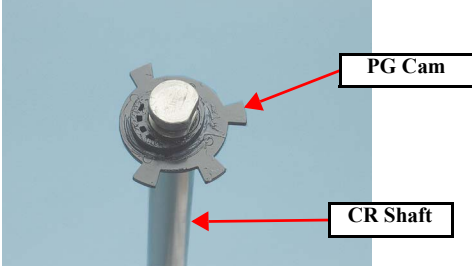
Table 3-7. Troubleshooting for Ink Cartridge Detection Error/ Ink Cover Open Error/ Cartridge Empty Error

Occurrence Timing	Symptom	Failed Part	Check Point	Remedy	Reference
At power-on	The error appears after the carriage home position is detected.	Ink Cartridge	1. Is the memory chip on the cartridge chipped or broken? 	1. Replace the ink cartridge.	-
		Head FFC	1. Is the Head FFC not connected to the Head Board and the Main Board?	1. Connect the Head FFC to the Head Board and the Main Board. ■ R360/R380/R390 Main Board: CN10,CN11,CN12 ■ R260/R265/R270 Main Board: CN10,CN11,CN12	4.5.12 "CR Unit"(p.105) / 4.3.2 "Removing the Main Board Unit"(p.78)
		Head Board	1. Are the CSIC terminals chipped or broken?  2. Is the Head Board damaged? 	1. Replace the CSIC ASSY. 2. Replace the CSIC ASSY.	4.5.3 "Printhead"(p.91)

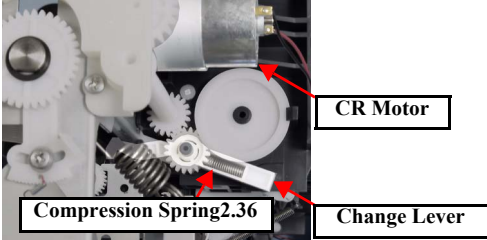
Table 3-8. Troubleshooting for Paper Jam Error

Occurrence Timing	Symptom	Failed Part	Check Point	Remedy	Reference
Any time	Even though the printer performs paper feeding operation, the paper is not fed into the printer.	ASF Unit	1. Is the ASF Unit installed incorrectly? 2. Is the Paper Return Lever not moving properly during the feeding operation?	1. Install the ASF Unit correctly. 2. Install the Paper Return Lever and the Torsion Spring 6.45 correctly.	4.5.11 "ASF Unit"(p.104)
		Front Paper Guide Assy	1. Is the Torsion Spring 0.22 attached incorrectly? 	1. Install the PE Sensor Lever and Torsion Spring 0.22 correctly.	4.5.14 "Front Paper Guide Assy/APG Sensor Assy"(p.109)
	Multiple sheets are fed at a time.	ASF Unit	1. Is the Retard Roller Assy not moving properly during the feeding operation? 	1. Attach the Extension Spring 1.98 on the back side of the Retard Roller Assy correctly.	4.5.11 "ASF Unit"(p.104)
Any time	Paper is fed into the printer, but ejected at once without any printing operation.	PE Sensor	1. Is the PE sensor cable not connected to the Main Board?	1. Connect the cable to the Main Board. ■ R360/R380/R390 Main Board: CN8 ■ R260/R265/R270 Main Board: CN6	4.3.2 "Removing the Main Board Unit"(p.78)
			1. Is the PE Sensor damaged?	2. Replace the PE Sensor.	4.5.14 "Front Paper Guide Assy/APG Sensor Assy"(p.109)

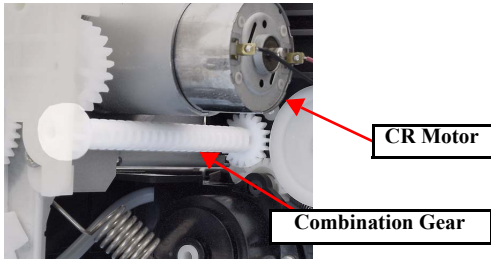
Table 3-8. Troubleshooting for Paper Jam Error

Occurrence Timing	Symptom	Failed Part	Check Point	Remedy	Reference
Any time	Paper is fed into the printer, but ejected at once without any printing operation.	PE Sensor	3. Is the Torsion Spring 0.22 detached or attached incorrectly?	3. Install the PE Sensor Lever and the Torsion Spring 0.22 correctly.	4.5.14 "Front Paper Guide Assy/APG Sensor Assy"(p.109)
					
	Paper cannot go through between the EJ Roller and the Star Wheel Roller.	Front Paper Guide Pad	1. Is the Front Paper Guide Pad attached incorrectly?	1. Install the pad correctly.	4.5.14 "Front Paper Guide Assy/APG Sensor Assy"(p.109)
		EJ Frame ASSY*	1. Is the Star Wheel Holder detached?	1. Attach the Star Wheel Holder correctly.	
				2. Is the EJ Frame Assy installed incorrectly?	
		3. Has the EJ Frame Assy become deformed obstructing the paper path?	3. Replace the EJ Frame Assy.		
	The leading edge of paper does not reach the PF Roller.	Upper Paper Guide*	1. Is the Upper Paper Guide disengaged from the Main Frame?	1. Install the Upper Paper Guide correctly.	4.5.12 "CR Unit"(p.105)

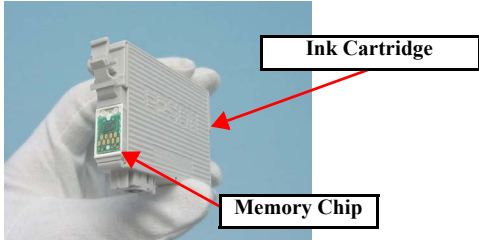
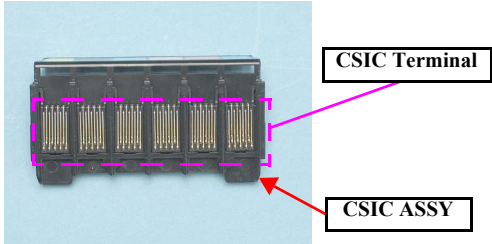
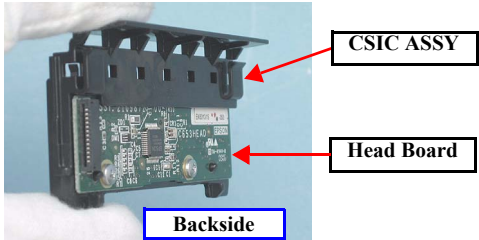
Note : * Be careful not to let jammed paper rub against the nozzle surface of the Printhead, or it may damage the Printhead.

Table 3-9. Troubleshooting for No Paper Error

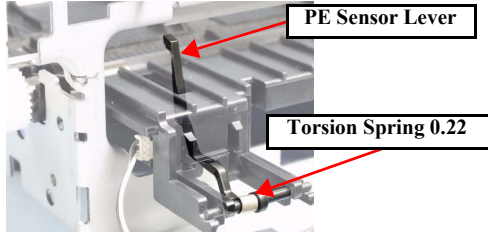
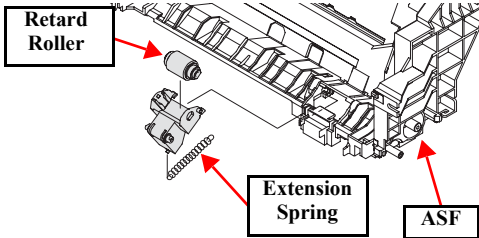
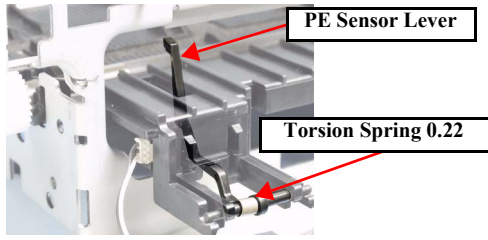
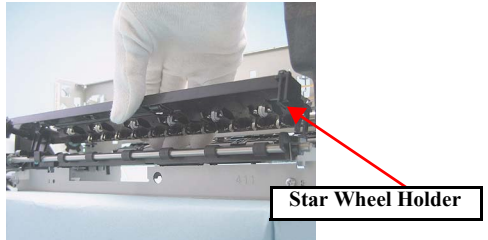
Occurrence Timing	Symptom	Failed Part	Check Point	Remedy	Reference
Any time	The LD Roller rotates normally to feed paper, but the Hopper does not move.	ASF Assy	1. Is the Hopper not moving properly during the feeding operation?	1. Attach the Compression Spring 2.51 correctly to the ASF Frame and the Hopper.	4.5.11 "ASF Unit"(p.104)
	The LD Roller rotates normally, but paper is not fed into the printer.	ASF Assy	1. Is there any paper dust on the LD Roller?	1. Remove the paper dust on the LD Roller with a cloth moistened with alcohol. * If this does not solve the problem, replace the ASF Unit.	
	The PF Motor drive force is not transmitted to the LD Roller shaft.	ASF Assy	1. Is the Extension Spring 0.143 of the clutch mechanism detached? 	1. Attach the Extension Spring 0.143 correctly.	
			2. Is the protrusion of the clutch chipped or broken? 	2. Replace the ASF Unit.	

Table 3-9. Troubleshooting for No Paper Error

Occurrence Timing	Symptom	Failed Part	Check Point	Remedy	Reference
Any time	The PF Motor drive force is not transmitted to the LD Roller.	ASF Assy	3. Is the clutch damaged? 	3. Replace the ASF Unit.	4.5.11 "ASF Unit"(p.104)
			4. Is the Compression Spring 2.36 of the Change Lever detached? 	4. Replace the ASF Unit. For R360/R380/R390, replace the Change Lever.	
	The LD Roller shaft is not set in the ASF home position, and paper is always fed from the ASF Assy.	ASF Assy	1. Is the edge of the Change Lever chipped or broken? 	1. Replace the ASF Unit. For R360/R380/R390, replace the Change Lever.	

Table 3-10. Troubleshooting for CDR Tray Error

Occurrence Timing	Symptom	Failed Part	Check Point	Remedy	Reference
When printing on CDs/DVDs	The CDR Tray is set to the printer, but the error occurs.	CDR Tray	1. Has the part of the CDR Tray that contacts with the CDR Tray Sensor become cracked? 	1. Replace the CDR Tray.	-
		CDR Guide Detection ASSY	1. Is the CDR Guide Detection Assy cable not connected to the Main Board? 2. Is the CDR Tray Sensor damaged?	1. Connect the cable to the Main Board. ■ R360/R380/R390 Main Board: CN9 ■ R260/R265/R270 Main Board: CN4 2. Replace the CDR Guide Detection Assy.	4.5.15 "CDR Guide Detection Assy"(p.111)
	The CDR Tray center detection sequence is interrupted, and the tray is ejected.	CDR Tray	1. Is there any paper dust or foreign matter on the white mark on the CDR Tray? 	1. Remove any dust or foreign matter from the tray.	-

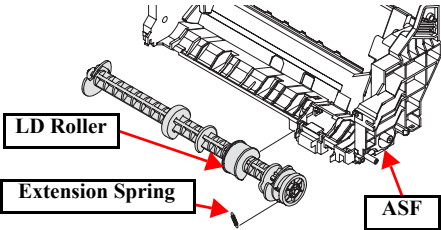
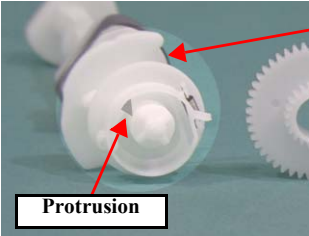
Table 3-10. Troubleshooting for CDR Tray Error

Occurrence Timing	Symptom	Failed Part	Check Point	Remedy	Reference
When printing on CDs/DVDs	The CDR Tray center detection sequence is interrupted, and the tray is ejected.	PW Sensor	1. Is there any paper dust or ink stain on the PW Sensor? 	1. Clean off any dirt on the PW Sensor.	4.5.12 "CR Unit"(p.105)
			2. Is the PW Sensor cable not connected to the CR Encoder Board and the PW Sensor?	2. Connect the PW Sensor cable to the CR Encoder Board and the PW Sensor.	
		PW Sensor	3. Is the PW Sensor cable broken?	3. Replace the CR Unit.	4.5.12 "CR Unit"(p.105)
			4. Is the PW Sensor damaged?	4. Replace the CR Unit.	
		Main Board	1. Is there any chipped or broken elements on the Main Board?	1. Replace the Main Board.	4.3.2 "Removing the Main Board Unit"(p.78)

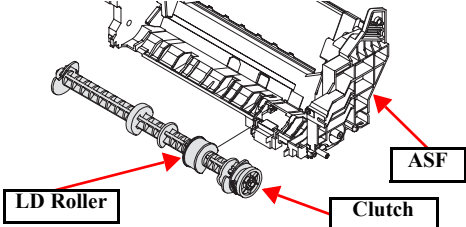
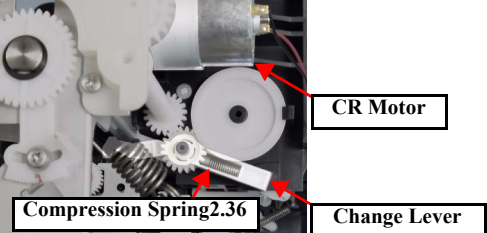
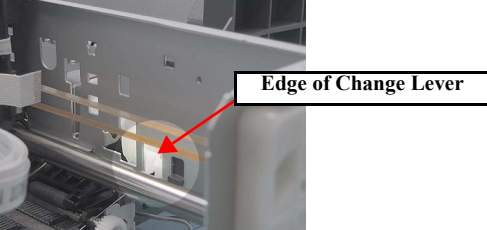
Table 3-11. Troubleshooting for CDR Guide Error

Occurrence Timing	Symptom	Failed Part	Check Point	Remedy	Reference
When printing on CDs/DVDs	The CDR Guide is set correctly, but the error occurs.	CDR Guide Detection ASSY	1. Is the CDR Guide Detection Assy cable not connected to the Main Board?	1. Connect the cable to the Main Board. <ul style="list-style-type: none"> ■ R360/R380/R390 Main Board: CN9 ■ R260/R265/R270 Main Board: CN4 	4.5.15 "CDR Guide Detection Assy"(p.111)
			2. Is the CDR Guide Sensor damaged?	2. Replace the CDR Guide Detection Assy.	
			3. Is the CDR Guide Detection Assy cable broken?	3. Replace the CDR Guide Detection Assy.	
		CDR Guide Lever	1. Is the CDR Guide Lever not installed correctly?	1. Install the CDR Guide Lever correctly.	4.5.6 "Stacker Assy"(p.95)
		Main Board	1. Is there any chipped or broken elements on the Main Board?	1. Replace the Main Board.	4.3.2 "Removing the Main Board Unit"(p.78)

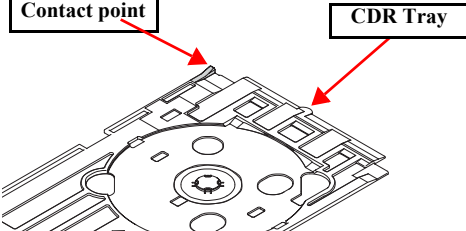
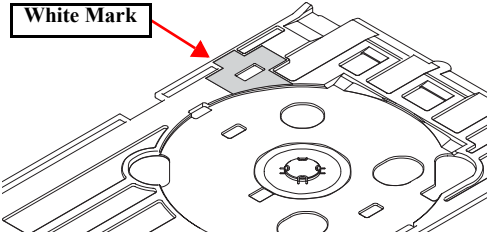
3.4 Troubleshooting by Symptom

3.4.1 Problems in Printing Operation

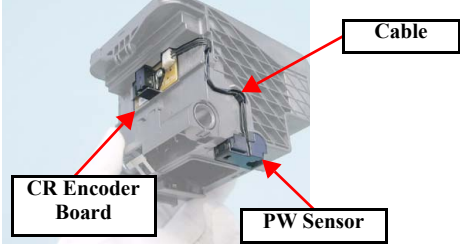
This section provides how to troubleshoot the possible problems on the printer mechanism. No error message appears for most of the troubles described here. In the following tables, find the symptom you face and follow the troubleshooting procedure given in the table.

□ Paper Feeding Problems

Table 3-12. Troubleshooting Paper Feeding Problems

Symptom	Possible Cause	Check Point	Remedy
Paper is not fed into the printer.	The LD Roller is contaminated or worn-out	Is there any “micro pearl” paper dust or oil stain on the LD Roller?	Use a cleaning sheet in order to clean the rollers. 1. Set a cleaning sheet in the ASF turning the sheet upside down. 2. Press the button on the operation panel to load the sheet. 3. Repeat the above procedure several times.
			In order to remove a severe smear, staple a cloth moistened with alcohol to a post card and carry out the following operations. 1. Set the post card in the ASF with the attached cloth facing the LD Roller or Retard Roller. 2. Then, holding the top edge, press the button on the operation panel to load the card. 3. Repeat Step 2. The paper dust or oil stain on the LD Roller or the Retard Roller surface is removed. If this does not solve the problem, replace the LD or Retard Roller.
	The Pickup Roller and Idle Roller are contaminated or worn-out	Is there any “micro pearl” paper dust or oil stain on the Pickup and Idle Rollers?	Wipe the roller surface with a cloth moistened with alcohol.
	Malfunction of the Paper Feed Mechanism	Is there a malfunction of the Paper Feeding Mechanism?	<input type="checkbox"/> Correct the phases of the Paper Feed Mechanism. <input type="checkbox"/> Remove any dust or foreign matter in the Paper Feed Mechanism.
Malfunction of the PE Sensor and PE Lever		Is the PE Sensor connector disconnected from the Main Board or the sensor?	Connect the PE Sensor cable to the Main Board and the PE Sensor correctly. R360/R380/R390: CN8 / R260/R265/R270: CN6
		Is the Torsion Spring 0.22 detached or attached incorrectly?	Attach the Torsion Spring 0.22 and the PE Lever correctly.
		Is the PE Sensor damaged?	Replace the PE Sensor.

Table 3-12. Troubleshooting Paper Feeding Problems

Symptom	Possible Cause	Check Point	Remedy
Multiple sheets are fed at a time.	A malfunction of the Retard Roller	Is the Extension Spring 1.98 at backside of the Retard Roller detached?	Attach the Extension Spring correctly.
			
		Is the Retard Roller detached?	INstall the Retard Roller correctly.

□ Problems with ejecting paper

Table 3-13. Troubleshooting Paper Ejecting Problems

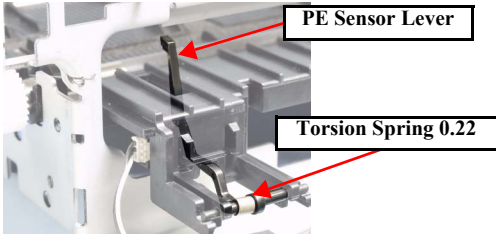
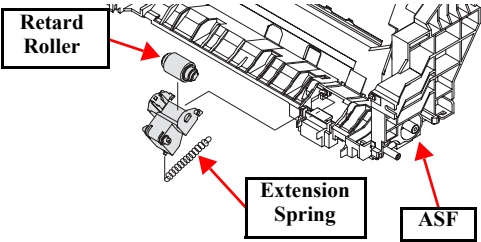
Symptom	Possible Cause	Check Point	Remedy
Paper jam occurs during ejecting paper.	A malfunction of paper feeding mechanism	Is the PF Roller not moving correctly without its drive force transmitted to the EJ Roller?	Engage the gears in the paper feed mechanism correctly.
	A malfunction of EJ Roller	Is the EJ Roller moving correctly?	Engage the gears which transmit drive force to the EJ Roller.

□ Problems with carriage (CR Unit) movements

Table 3-14. Troubleshooting Carriage Movement Problems

Symptom	Possible Cause	Check Point	Remedy
Movements of the CR Unit during printing is abnormal.	Something interferes with the operation of the CR Unit.	Is there any obstruction on the carriage path?	Remove the obstruction.
		Move the CR Unit with your hand. The unit does not move smoothly?	Clean the CR shaft and apply grease.
		Is the slack of the Head FFC not enough or too much interfering the carriage movement? Check that by moving the carriage from side to side with your hand.	Route the Head FFC around the Main Frame correctly.

☐ Printer initialization operation is aborted

Table 3-15. Troubleshooting Initialization Stop Problems

Symptom	Possible Cause	Check Point	Remedy
An error occurs during initialization after power-on	Improper installation of the EJ Frame	Are the tabs of the EJ Frame disengaged?	Reinstall the EJ Frame correctly.
	A malfunction of the CR Motor	Is the CR Motor cable/connector disconnected?	Connect the CR Motor cable/connector properly. R360/R380/R390: CN14 / R260/R265/R270: CN14
	A malfunction of the PF Motor	Is the PF Motor cable/connector disconnected?	Connect the PF Motor cable/connector properly. R360/R380/R390: CN15 / R260/R265/R270: CN13
	CR linear Scale failure	Is the CR Linear Scale not moving freely, centered between the sides of CR encoder sensor?	Install the scale correctly.
		Is there any dirt on the CR Linear Scale?	Clean off any dirt on the scale.
		Is the CR Linear Scale chipped or broken?	Replace the CR Linear Scale.
	A malfunction of the CR Encoder	Is the Encoder FFC disconnected from the CR Encoder Board?	Connect the FFC to the board properly.
		Is there any paper dust or dirt on the CR Encoder?	Remove any paper dust or dirt on the CR Encoder.
		Is the Encoder FFC damaged or broken?	Replace the Head FFC.
		Is the CR Encoder damaged or broken?	Replace the CR Unit.
	PF Scale failure	Is the PF Scale not moving freely, centered between the sides of PF encoder sensor?	Install the scale correctly.
		Is there any dirt on the PF Scale?	Clean off any dirt on the scale.
		Is the PF Scale chipped or broken?	Replace the PF Scale.
	A malfunction of the PF Encoder	Is the Encoder FFC disconnected from the PF Encoder Board?	Connect the FFC to the board properly.
		Is there any paper dust or dirt on the PF Encoder?	Remove any paper dust or dirt on the PF Encoder.
		Is the Encoder FFC broken?	Replace the Encoder FFC.
		Is the PF Encoder damaged or broken?	Replace the PF Encoder.
	Head FFC failure	Is the Head FFC disconnected?	Connect the FFC properly. R360/R380/R390: CN5, CN10, CN11, CN12, CN13 R260/R265/R270: CN10, CN11, CN12, CN15, CN16
		Is the Head FFC damaged or broken?	Replace the Head FFC.
	Printhead failure	Are the all nozzles not firing ink properly?	Replace the Printhead.

□ Print quality problems

Table 3-16. Troubleshooting Print Quality Problems

Symptom	Possible Cause	Check Point	Remedy
Printed image has missing colors, and the missed colors are always same.	Dirt on the Printhead.	Run a cleaning cycle and make a test print. Repeat the operation several times. Does the problem still appear?	Clean the Printhead surface with a cotton swab.
	The absorber of the Cap Unit contacts with the Printhead surface during printing.	Is the absorber of the Cap Unit deformed or damaged?	Replace the Ink System.
	Head FFC failure	Is the Head FFC damaged or broken?	Replace the Head FFC.
	A malfunction of the Printhead	Run a cleaning cycle and print a nozzle check pattern. Repeat the operation several times. Does the problem still appear?	Replace the Printhead.
Missing dots appear sometimes.	Dirt on the Printhead.	Run a cleaning cycle and print a nozzle check pattern. Repeat the operation several times. Does the problem still appear?	Clean the Printhead surface with a cotton swab.
	Ink cartridge failure	Replace the ink cartridge with a new one, and print a nozzle check pattern. The printed pattern has no missing dots?	The cartridge is defective. Use the new cartridge.
	Poor connection of the Head FFC	Check the FFC with a tester. Does the result show poor connection of the FFC?	Replace the Head FFC.
	A malfunction of the Printhead	Run a cleaning cycle and print a nozzle check pattern. Repeat the operation several times. Does the problem still appear?	Replace the Printhead.
White streak / abnormal discharge	Poor connection of the Head FFC	Is the Head FFC not securely connected to the CR Unit and boards?	Connect the FFC correctly.
	A malfunction of the Printhead	Is the Head FFC not securely connected to the Printhead?	Connect the FFC correctly. If there is no problem with the connection status, replace the Printhead.
Vertical lines are misaligned.	Improper Bi-D adjustment	Using the Adjustment Program, check the Bi-D setting. Is the setting made properly?	Carry out the Bi-D adjustment properly.

Table 3-16. Troubleshooting Print Quality Problems

Symptom	Possible Cause	Check Point	Remedy
Printed image has white banding.	Dirt on the CR shaft	Is there any dirt on the CR shaft?	Clean off any dirt on the CR shaft surface with a dry soft cloth.
	PF Roller failure	Is there any dirt on the PF Roller?	Clean the PF Roller surface with a soft brush carefully so as not scratch it.
		Is the PF Roller damaged?	Replace the PF Roller.
	Ink cartridge failure	Replace the ink cartridge with a new one, and print a nozzle check pattern. The printed pattern has no missing dots?	The cartridge is defective. Use the new cartridge.
	A malfunction of Carriage movements	Are the carriage shaft and the Main Frame properly lubricated?	Apply G-71 grease referring to "Lubrication of CR Unit"(p.133).
	Improper platen gap	Is the platen gap (gap between the Printhead surface and the platen) not properly set?	Adjust the platen gap properly.
	Some gear(s) is (are) damaged.	Is (are) the gear(s) in the paper feed and ASF mechanisms damaged?	Replace the damaged gear(s).
	Dirt on the Printhead is preventing nozzles from firing ink straight toward the paper.	Run a cleaning cycle and make a test print. Repeat the operation several times. Does the problem still appear?	Clean the Printhead surface with a cotton swab.
		Is there any dust or foreign matter on the Cleaner Blade?	Remove any dust or foreign matter on the Cleaner Blade, or replace the blade.
	A malfunction of the Printhead	Run a cleaning cycle and make a test print. Repeat the operation several times. Does the problem still appear?	Replace the Printhead.
CR shaft failure	Is the CR shaft not properly installed?	Reinstall the CR shaft properly.	
	Is the CR shaft surface damaged?	Replace the CR shaft.	

3.4.2 Power Problems

The printer does not work at all after power-on. LEDs do not light up.

Table 3-17. Troubleshooting Power Problems

Possible Cause	Check Point	Remedy
Power code failure	Replace the power code with a new one. Does the printer work normally?	The power code is defective. Use the new one.
Improper power supply	Do the power supplied from the AC line match with the electrical requirements of the printer?	Use an AC line that matches the printer electrical requirements.
Poor connection of the PS Assy connector	Is the PS Assy connector not properly connected to the Main Board? R360/R380/R390: CN16 / R260/R265/R270: CN3	Connect the connector properly.
The fuse burned out	Is the fuse (F1) on the PS Board burned out?	Replace the PS Board.
Abnormal voltage output of the PS Board	Check the voltage output from the PS Board. Is it abnormal?	When the voltage is normal: Replace the Main Board. When the voltage is abnormal: Replace the PS Assy.

3.4.3 Ink-related Problems

- Printer stops halfway through its initialization process or printing operation.

Table 3-18. Troubleshooting Ink Supply Problems

Symptom	Possible Cause	Check Point	Remedy
An Ink Out error occurs.	The cartridge is empty.	Is the ink cartridge empty?	Replace the cartridge with a new one.
A No Cartridge error occurs.	The printer cannot detect the ink cartridge.	Are ink cartridges not installed in the IC Holder?	Install ink cartridges.
		Are the ink cartridges not properly installed?	Set the cartridges properly.
		Are the top and bottom tabs of the ink cartridge broken?	Replace the cartridge with a new one.
An ink cartridge error occurs.	Ink cartridge is damaged.	Is the CSIC Board not properly attached?	Replace the cartridge with a new one.
		Is there any chipped or broken elements on the CSIC Board?	Replace the cartridge with a new one.

- Printing cannot be made properly (printed image is faint, blurry, smeared, or etc.)

Table 3-19. Troubleshooting Printing Problems

Symptom	Possible Cause	Check Point	Remedy
The carriage moves normally, but the printed image is abnormal.	Ink cartridge failure	Replace the ink cartridge with a new one, and make a test print. The printed pattern has no missing dots?	The cartridge is defective. Use the new one.
	Poor connection of the Head FFC	Is the FFC not properly connected to the CSIC Board and the Main Board?	Connect the FFC correctly.
	Cleaner Blade failure	Is there any dust or foreign matter on the Cleaner Blade?	Remove the dust or foreign matter on the Cleaner Blade, or replace the blade.
	Poor connection of the Head FFC	Check the FFC using a tester. Is there any abnormality in the result?	Replace the Head FFC.
	A malfunction of the Printhead	Run a cleaning cycle and make a test print. Repeat the operation several times. Does the problem still appear?	Replace the Printhead.
	Ink leakage, clogging	Is there any ink leakage found in the Printhead?	Reinstall the ink cartridge correctly. If this does not solve the problem, replace the ink cartridge, or the Printhead.

- Waste ink is not properly drained out of the Printhead or the Cap Unit.

Table 3-20. Troubleshooting Waste Ink Problems

Symptom	Possible Cause	Check Point	Remedy
Waste ink is not properly drained out of the Printhead or the Cap Unit, and not properly transported to the Waste Ink Tube.	The pump tube failure	Is there any collapsed sections of the tube?	Replace the Ink System.
	Cap failure	Is there any foreign matter on the cap, or is the cap damaged?	Remove the foreign matter on the cap with a cotton swab. Replace the cap in case that the cap is damaged.
	Disconnection of the tube	Is the tube disconnected from the Cap Unit?	Connect the tube correctly.
	A malfunction of cap movement	Is the Compression Spring of the Cap Assy detached, broken, or missing?	Replace the Ink System.
	The tube between the Waste Ink Tray and the Ink System Assy is at fault.	Is the tube not properly inserted in the Waste Ink Tray Assy, or not properly routed under the tray?	Securely connect the tube to the Waste Ink Tray Assy routing the tube correctly.

3.4.4 Problems with Interfaces

This section provides how to troubleshoot problems on the USB interface and memory card slot.

□ USB interface error

Table 3-21. Troubleshooting USB Connection Errors

Possible Cause	Check Point	Remedy
The printer driver has not been installed correctly.	On the Windows PC, go to My Computer, Properties, Hardware, Device Manager. Is the printer driver associated with Other Devices?	Uninstall the driver and reinstall it correctly following the instruction described in the User's Guide.
USB cable failure	Replace the USB cable with a new one. Does the USB communication between the printer and PC return to normal?	The USB cable is defective. Use the new one.
Poor connection of the USB terminals	Is there any foreign matter on the USB terminal?	Remove the foreign matter.
Main Board failure	Is the Main Board damaged or broken?	Replace the Main Board.

□ Memory card-related problems (R360/R380/R390 only)

Table 3-22. Troubleshooting Memory Card Problems

Possible Cause	Check Point	Remedy
Memory card data failure (data in the card may have been damaged by static electricity or etc.)	Using other device such as PC, check the memory card if files in the card can be read normally. Can the device also not read the files?	Advise the user to format the memory card or use a new one.
Unsupported memory card	Is the memory card a type not supported by the printer?	Use a memory card supported by the printer.
Memory card failure	Replace the card with another one. Does the printer recognize the card?	The card is defective. Use the another one.
Contact failure	Is there any foreign matter attached to the memory card or in the card slot?	Remove the foreign matter or dirt.
	Is there any bent or broken pins in the card slot?	Replace the Card Board.
Firmware failure	—	Download and install the latest firmware.
Electric noise	Check inside the printer. Is there any disconnected FFCs, or ferrite cores not located properly?	If no such statuses are found, replace the Main Board.
Main Board failure	Is the Main Board damaged or broken?	Replace the Main Board.

CHAPTER

4

DISASSEMBLY/ASSEMBLY

4.1 Overview

This section describes procedures for disassembling the main components of the Stylus Photo R260/R265/R270 and R360/R380/R390

Unless otherwise specified, disassembled units or components can be reassembled by reversing the disassembly procedure.

Procedures which, if not strictly observed, could result in personal injury are described under the heading “WARNING”.

“CAUTION” signals a precaution which, if ignored, could result in damage to equipment.

Important tips for procedures are described under the heading “CHECK POINT”.

If the assembly procedure is different from the reversed disassembly procedure, the correct procedure is described under the heading “REASSEMBLY”.

Any adjustments required after reassembly of components or parts are described under the heading “ADJUSTMENT REQUIRED”.

When you have to remove any components or parts that are not described in this chapter, refer to the exploded diagrams in the appendix.

The precautions in the two lists below (WARNING and CAUTION), must always be followed during disassembly and assembly.

4.1.1 Precautions

See the precautions given under the heading “WARNING” and “CAUTION” in the following column when disassembling Stylus photo R260/R265/R270 and R360/R380/R390.



- Disconnect the power cable before disassembling or assembling the printer.
- If you need to work on the printer with power applied, strictly follow the instructions in this manual.
- Wear protective goggles to protect your eyes from ink. If ink gets in your eye, flush the eye with fresh water and see a doctor immediately.
- Always wear gloves for disassembly and reassembly to avoid injury from sharp metal edges.
- Use static discharge equipment such as anti-static wrist straps when accessing internal components to protect sensitive electronic components and circuitry.
- Never touch the ink or wasted ink with bare hands. If ink comes into contact with your skin, wash it off with soap and water immediately. If irritation occurs, contact a physician.
- Make sure the tip of the waste ink tube is located at correct position when reassembling the waste ink tube, or it will cause ink leakage.



- When transporting, do not remove the ink cartridges. Pack the printer with the cartridges installed.
- Use only recommended tools for disassembly, assembly or adjustment of the printer. (*Table 4-1, “List of Tools,” on page 58*)
- Be sure to tighten the screws to the specified torque.
- Apply lubricants and adhesives as specified. (See Chapter 6 *Lubrication (p.131)* for details.)
- Make the specified adjustments when you disassemble the printer. (Chapter 5 contains additional information on adjustments.)
- When using compressed air products, such as air duster, for cleaning during repair and maintenance, the use of such products containing flammable gas is prohibited.
- Be careful not to scratch or damage the coating on exterior surface of the product during disassembly and reassembly.

4.1.2 Tools

Use only specified tools to avoid damaging the printer.

Table 4-1. List of Tools

Tool	Supplier*	Part No.
Phillips Screw Driver (No.1)	EPSON	1080530
Phillips Screw Driver (No.2)	EPSON	1080532
Flathead Screw Driver	EPSON	1080527
Precision Screw Driver #1 (flathead)	EPSON	1080525
Tweezers	EPSON	1080561
Long-nose pliers	EPSON	1080564
Acetate tape	EPSON	1003963
Metal straightedge	-	-
2 pins (thinner than Ø2mm)	-	-

Note *: Commercially available

4.1.3 Screws

The screws used in the printer are as shown in the table below. Make sure you always use the correct type and number of screws.

Table 4-2. List of Screw Types



No.	Description	Image
1	C.B.S 3x6	
2	C.B.S 3x8	
3	C.B.S 3x10	
4	C.B.P 2x6	

Table 4-2. List of Screw Types



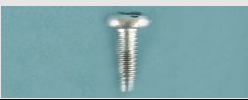
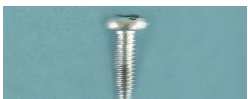

No.	Description	Image
5	C.B.P 2.6x8	
6	C.B.P 3x8	
7	C.B.P 3x10	
8	C.P.S 3x4	
9	C.P.S 3x6	
10	C.P.S 3x10	
11	C.B.S.(P4) 3x6	

Table 4-3. Screw Types

Abbreviation	Full Name
C.B.S	Phillips Bind S-Tite
C.B.P	Phillips Bind P-Tite
C.P.	Phillips Pan head
C.B.S.(P4)	Phillips Bind S-Tite Sems R2

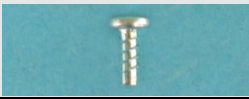
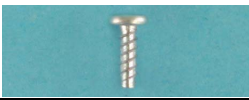
4.1.4 Work Completion Checklist

Whenever the printer is serviced, use the checklist shown below to confirm all work is completed properly and the printer is ready to be returned to the user.

Make sure to always check the maintenance counter before disassembling the printer. If the counter shows that some part or component has almost reached the end of its service life, replace the part after receiving prior approval from the user.

Table 4-4. Work Completion Checklist

Classification	Item	Check Point	Status
Printer Unit	Self-test	Is the operation normal?	<input type="checkbox"/> OK / <input type="checkbox"/> NG
	On-line Test	Is the printing attempt successful?	<input type="checkbox"/> OK / <input type="checkbox"/> NG
	Printhead (print a nozzle check pattern)	Is ink discharged normally from all the nozzles?	<input type="checkbox"/> OK / <input type="checkbox"/> NG
	Carriage Mechanism	Does the carriage move smoothly?	<input type="checkbox"/> OK / <input type="checkbox"/> NG
		Is there any abnormal noise during its operation?	<input type="checkbox"/> OK / <input type="checkbox"/> NG
	Paper Feeding Mechanism	Is paper advanced smoothly?	<input type="checkbox"/> OK / <input type="checkbox"/> NG
		No paper jamming?	<input type="checkbox"/> OK / <input type="checkbox"/> NG
		No paper skew?	<input type="checkbox"/> OK / <input type="checkbox"/> NG
		No multiple-sheet feeding?	<input type="checkbox"/> OK / <input type="checkbox"/> NG
		No abnormal noise?	<input type="checkbox"/> OK / <input type="checkbox"/> NG
	Is the paper path free of obstructions?	<input type="checkbox"/> OK / <input type="checkbox"/> NG	
On-line Test	On-line Test	Is the operation normal?	<input type="checkbox"/> OK / <input type="checkbox"/> NG
Adjustment	Specified Adjustments	Are all the adjustments correctly completed?	<input type="checkbox"/> OK / <input type="checkbox"/> NG
Lubrication	Specified Lubrication	Has lubrication been applied at the specified points?	<input type="checkbox"/> OK / <input type="checkbox"/> NG
		Is the amount of lubrication correct?	<input type="checkbox"/> OK / <input type="checkbox"/> NG
Function	Firmware Version	Version:	<input type="checkbox"/> OK / <input type="checkbox"/> NG

Table 4-4. Work Completion Checklist

Classification	Item	Check Point	Status
Packing	Ink Cartridge	Are the ink cartridges installed correctly?	<input type="checkbox"/> OK / <input type="checkbox"/> NG
	Waste Ink Pads	Is the remaining capacity of the waste ink pads enough?	<input type="checkbox"/> OK / <input type="checkbox"/> NG
	Carriage position	Is the carriage located at the position where the Printhead is covered with the cap?	<input type="checkbox"/> OK / <input type="checkbox"/> NG
	Protection (strong tape, vinyl sheet)	Have the specified parts been secured with the strong tapes to prevent damage during transportation? See Protection for transportation (p.60)	<input type="checkbox"/> OK / <input type="checkbox"/> NG
Others	Attachments, Accessories	Have all the relevant items been included in/returned to the package?	<input type="checkbox"/> OK / <input type="checkbox"/> NG

PROTECTION FOR TRANSPORTATION

Before packing the printer to be returned to the user, attach several pieces of strong tape and vinyl sheet to the specified points to prevent damaging the printer during transportation.

- Securing the Carriage (tape: 180mm x 1 pc., fold one end by 5mm)
 1. Attach 40mm-length portion of the tape (not folded side) to the left side of the carriage aligning the tape's corner with the carriage's ribs as shown below.
 2. Attach the folded side of the tape to the housing with the carriage locked at its lock position. (First move the carriage to the lock position, then attach the tape to the housing.)

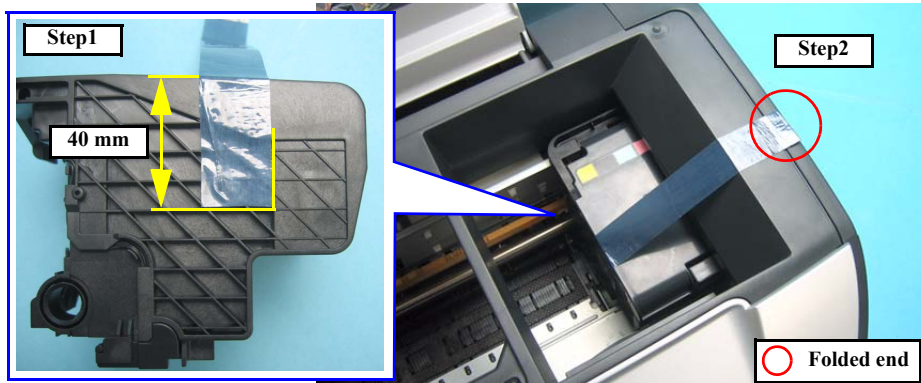

Figure 4-1. Securing the Carriage

- Securing the Paper Support (tape: 80mm x 3 pcs., fold one end by 5mm)

Attach the three pieces of strong tape to secure the Paper Support as shown below.

 - The left and right tapes should attach to the Paper Support and the side of the housing.

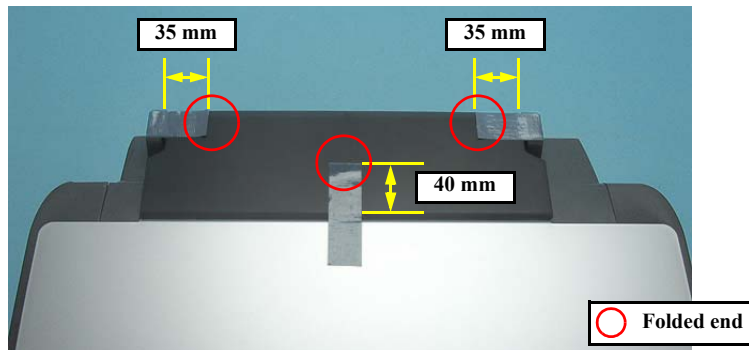

Figure 4-2. Securing the Paper Support

- Securing the Housing Middle (tape: 80mm x 2 pcs., fold one end by 5mm)

Attach the two pieces of strong tape to the rear of the Middle Housing as shown below.

 - The tape on the left should not lap over the serial number label.
 - The folded end of the tape on the right should align with the fifth ventilating slit from the right.



Figure 4-3. Securing the Middle Housing on its rear

- Securing the Stacker (tape: 60mm x 1 pc., fold one end by 5mm)

Attach the strong tape to the center of the Stacker as shown below. The edge and backside of the Stacker have irregular steps. Make sure to attach the tape along the shape.

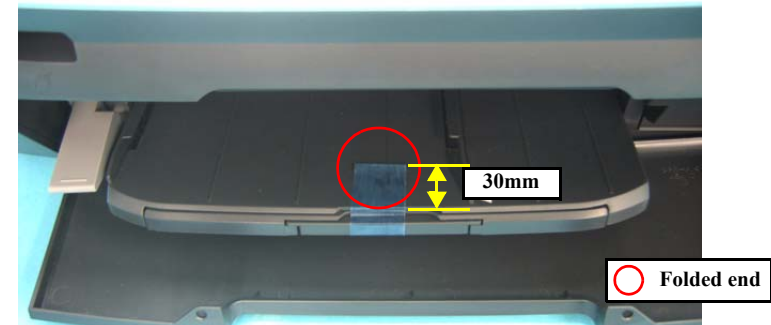

Figure 4-4. Securing the Stacker

- Protecting the exterior parts from scratches and scuff marks

Have a commercially available 250cm-width x 100cm-length vinyl sheet to cover the exterior parts, and secure the sheet with 60mm-length strong tape (fold one end by 5mm).

■ Front Cover

Fold the vinyl sheet in half, and insert the folded sheet between the Stacker Assy and the Front Cover with the folded side facing front side of the printer. Align the left and right edges of the sheet with the edges of the Stacker Assy and secure the sheet with the strong tape as shown below.

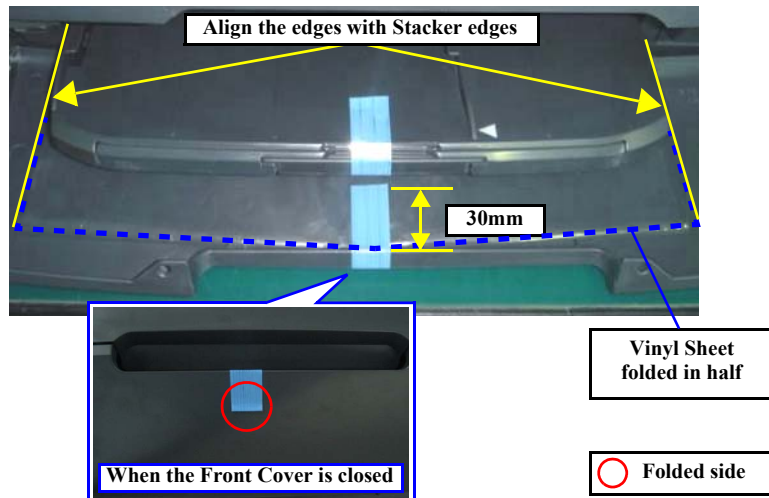

Figure 4-5. Protecting the Front Cover

■ Panel Unit (R260/R265/R270 only)

Fold the vinyl sheet in half, and put the sheet on the Panel Unit aligning the sheet's not-folded side with the upper edges of the buttons, and sheet's left edge with the left edge of the Panel Unit. Then secure the sheet with the strong tape.

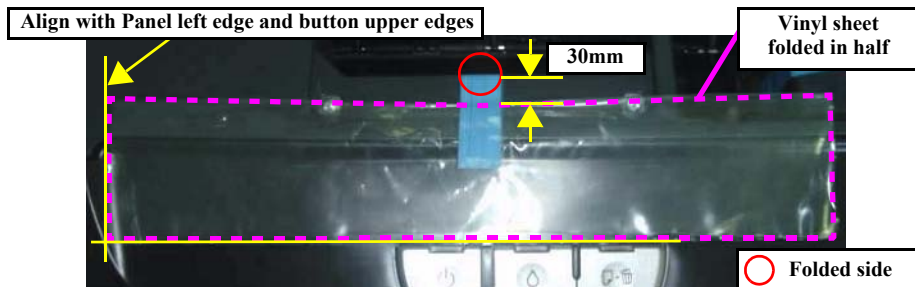

Figure 4-6. Protecting the Panel Unit (R260/R265/R270 only)

4.1.5 Required Preparation before Disassembly

Make sure to carry out the following operations before disassembling the printer.

- When the Main Board needs to be replaced, make a backup copy of EEPROM data.
- Unlock the carriage lock and move the CR Unit to other than its home position.
 - [How to Unlock the Carriage \(p62\)](#)

4.1.6 Orientation Definition

Orientation descriptions used in the disassembly/reassembly procedures are as follows.

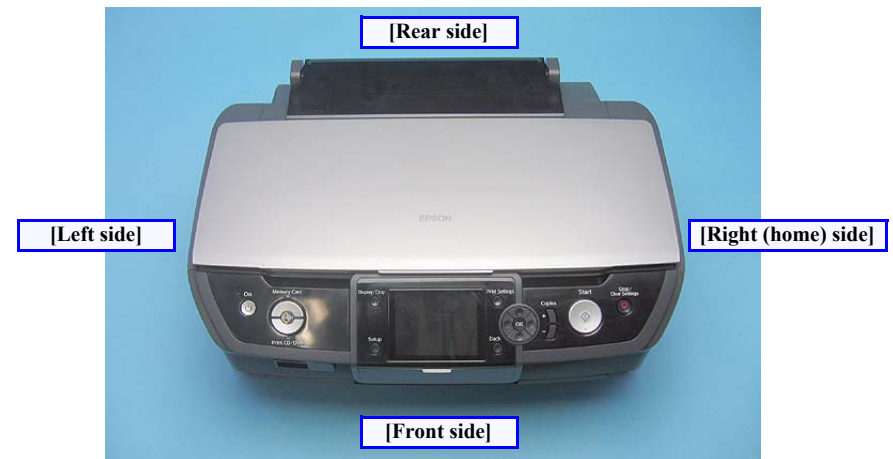

Figure 4-7. Orientation Definition

4.1.7 How to Unlock the Carriage

- Unlocking the carriage is required for disassembly of some parts or components. Carry out any of the following operations to unlock the carriage and move the carriage to other than its home position.

CAUTION !

Be extremely careful not to damage the EJ Roller gear. Extra care must be taken to avoid injury from sharp metal edges.

- Power the printer and turn it off forcibly by disconnecting the power cable when the CR Unit is unlocked and moved away from the home position.
- Turn the EJ Roller gear on the left side of the printer in the direction of the arrow until the carriage is unlocked.

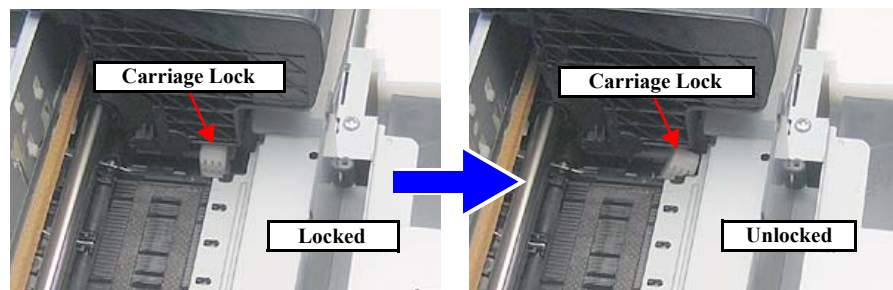
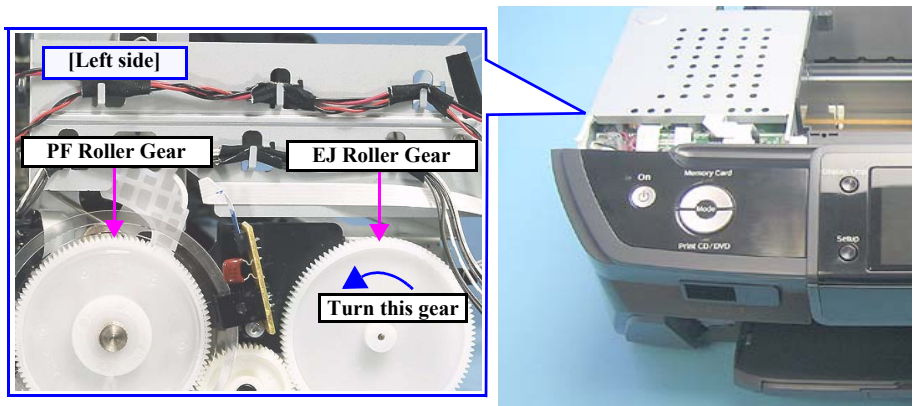

Figure 4-8. How to Unlock the Carriage

4.1.8 Sharp Metal Edges (Danger!)

CAUTION !

During disassembly/reassembly work on the Stylus R260/R265/R270 and R360/R380/R390, extra care must be taken to avoid injury from sharp metal edges, especially from the edges shown below.

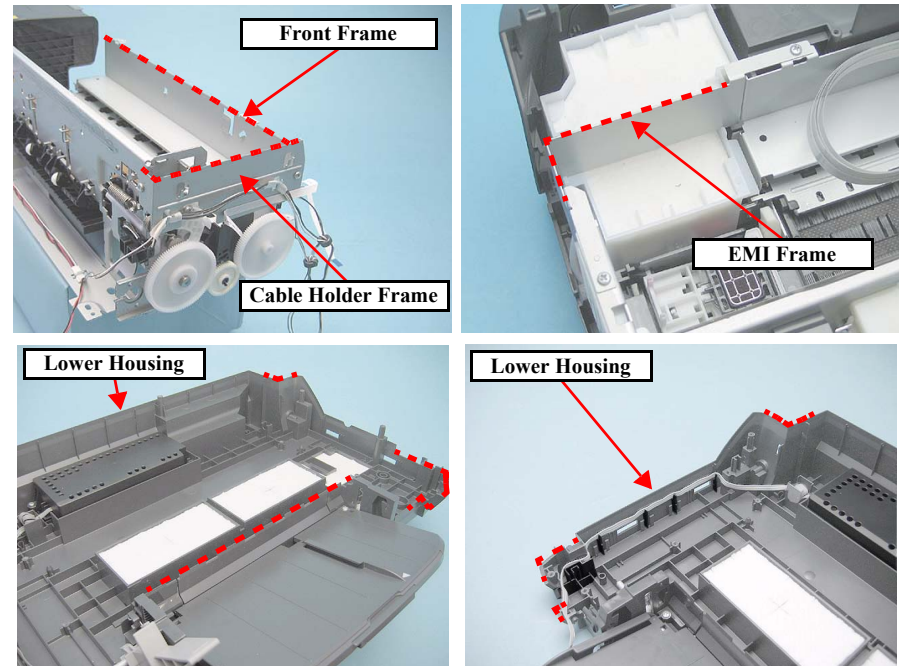
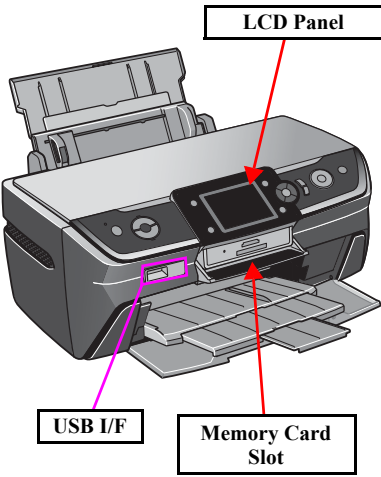
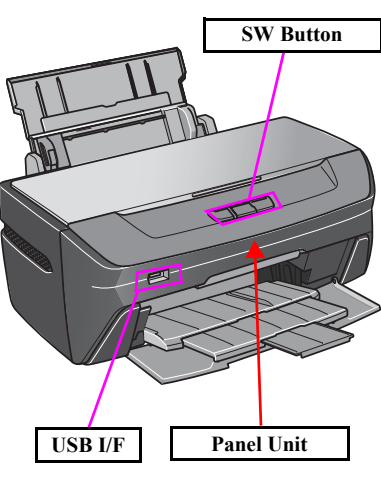
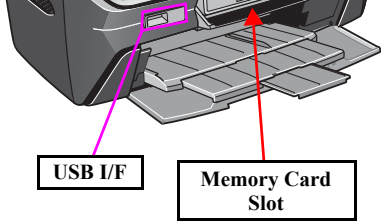
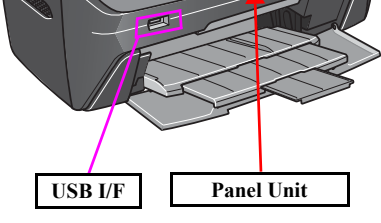
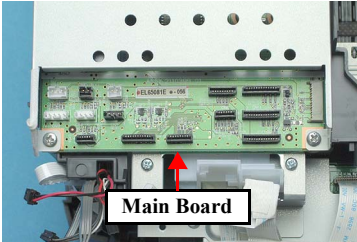
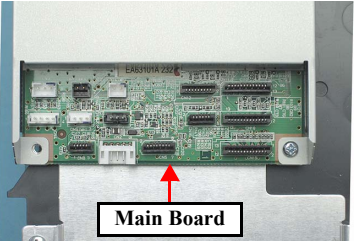
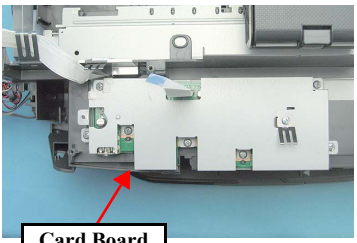
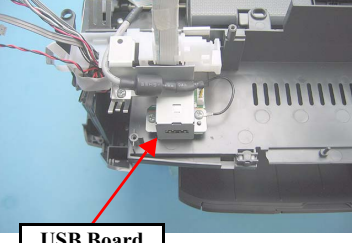

Figure 4-9. Sharp Metal Edges

4.1.9 Differences in Disassembly Procedure by Model

The table below lists the differences in disassembly procedure between the Stylus Photo R260/R265/R270 and R360/R380/R390. For more details on each procedure, refer to the page given in the Reference column.

Figure 4-10. List of Disassembly Procedure Differences

Part/Component Name	Description	R360/R380/R390	R260/R265/R270	Reference
Panel Board	<ul style="list-style-type: none"> R360/R380/R390 are equip with a LCD panel on the Panel Unit. The number of buttons on the operation panel and control boards differs between two models. 	 <p>LCD Panel</p>	 <p>SW Button</p>	<p>Panel Unit (p.69) Disassembling the Panel Unit (p.83)</p>
Front Housing / Slot Cover	<ul style="list-style-type: none"> The R360/R380/R390 are equip with memory card slots and USB interfaces. The R260/R265/R270 have USB interfaces only. 	 <p>USB I/F</p> <p>Memory Card Slot</p>	 <p>USB I/F</p> <p>Panel Unit</p>	<p>Front Housing (p.73)</p>
Main Board Unit	<ul style="list-style-type: none"> Because of the functional differences, the number and location of the connectors on the Main Board are different. 	 <p>Main Board</p>	 <p>Main Board</p>	<p>Removing the Main Board Unit (p.78) Disassembling the Main Board Unit (p.80)</p>
Card Board / USB Board	<ul style="list-style-type: none"> The R360/R380/R390 are equip with memory card slots. Control boards for the interfaces on the Middle Housing are different. 	 <p>Card Board</p>	 <p>USB Board</p>	<p>Removing the USB Board (R260/R265/R270 only) (p.76)</p>

4.1.10 Disassembly/Assembly Procedures

The flowchart below lists the step-by-step disassembly procedures. When disassembling each unit, refer to the page number shown in the figure.

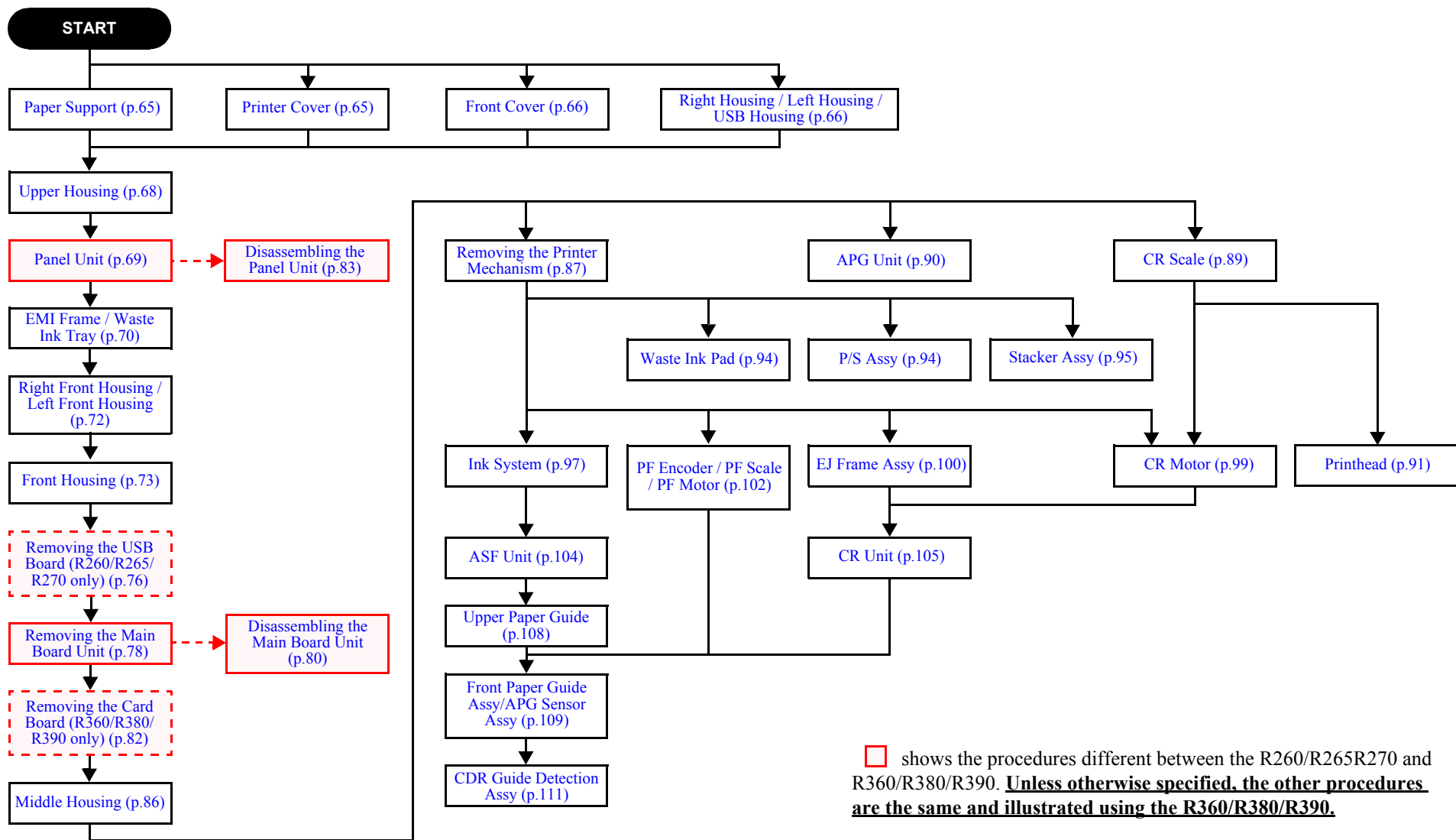

□ shows the procedures different between the R260/R265/R270 and R360/R380/R390. **Unless otherwise specified, the other procedures are the same and illustrated using the R360/R380/R390.**

Flowchart 4-1. R260/R265/R270 & R360/R380/R390 Disassembly Flowchart

4.2 Removing Exterior Parts/Components

4.2.1 Paper Support

- Parts/Components need to be removed in advance: Nothing
- Removal procedure
 1. Open the Paper Support.
 2. Disengage the right shaft of the Paper Support from the bushing of the ASF Unit by pushing the bushing outward. Then remove the Paper Support, disengaging the left shaft preventing the Edge Guide projection from hitting against the other parts.

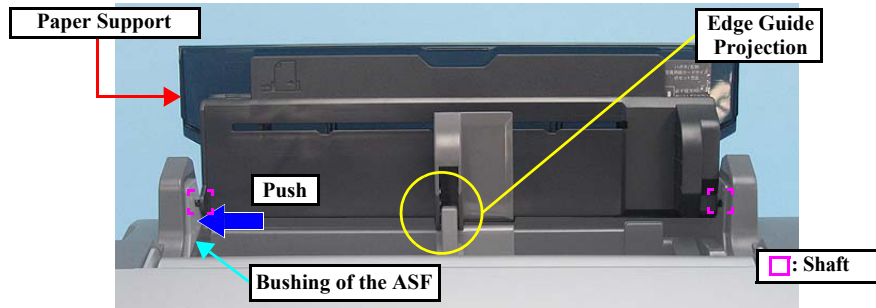

Figure 4-11. Removing the Paper Support



When reinstalling the Paper Support, match the projection and hole of the Edge Guide, then attach the right shaft and the left shaft in that order. (Put the shafts at the front side in the bushing and then push them rearward.) After reinstalling, check that the Paper Support moves smoothly.

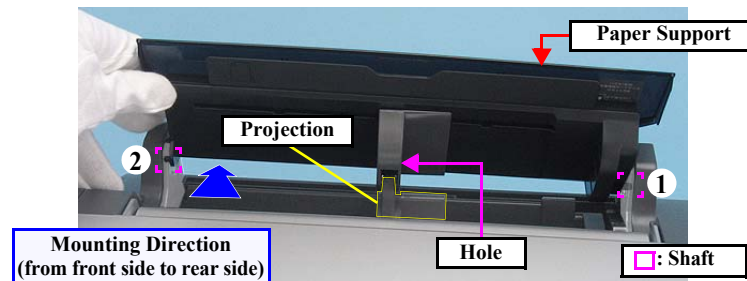

Figure 4-12. Reinstalling the Paper Support

4.2.2 Printer Cover

- Parts/Components need to be removed in advance: Nothing
- Removal procedure
 1. Open the Printer Cover.
 2. Pull out the left shaft and right shaft of the Printer Cover in that order, and remove the Printer Cover.



Figure 4-13. Removing the Printer Cover (1)



When an instruction label needs to be attached, attach it aligning with the line marked on the back of the Printer Cover. Make sure it is in the correct orientation as shown below.

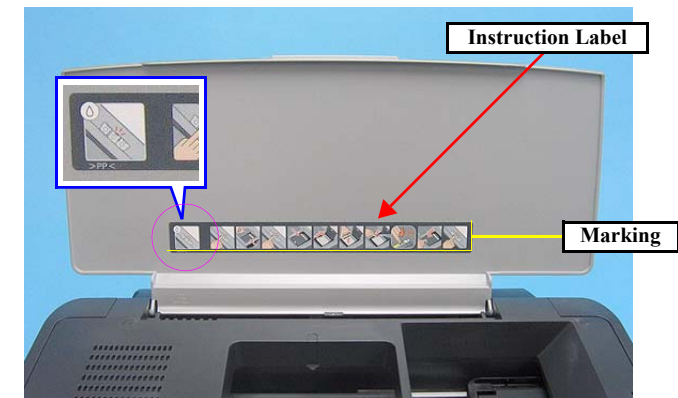



Figure 4-14. Attaching the Instruction Label

4.2.3 Front Cover

- Parts/Components need to be removed in advance: Nothing
- Removal procedure
 1. Open the Front Cover.
 2. Raise the CDR Guide Lever to lower the Stacker.
 3. While pushing , disengage the left and right positioning holes of the Front Cover in that order, and remove the Front Cover.

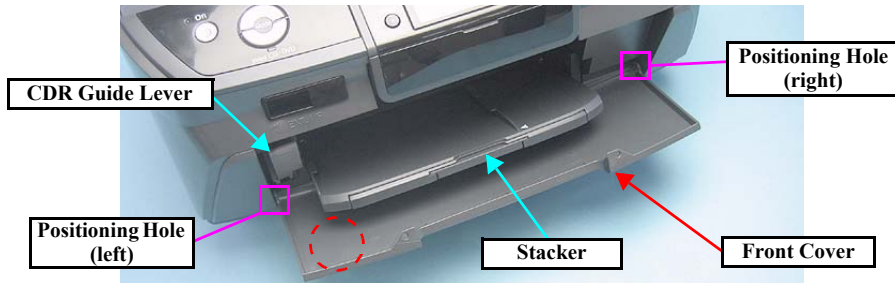



Figure 4-15. Removing the Front Cover (1)

4.2.4 Right Housing / Left Housing / USB Housing

- Parts/Components need to be removed in advance: Nothing
- Removal procedure
 - Removing Right/Left Housings
 1. Remove the two screws.
 - Screw  : C.B.P. M3x10 (tightening torque: 5-7 kgf.cm)

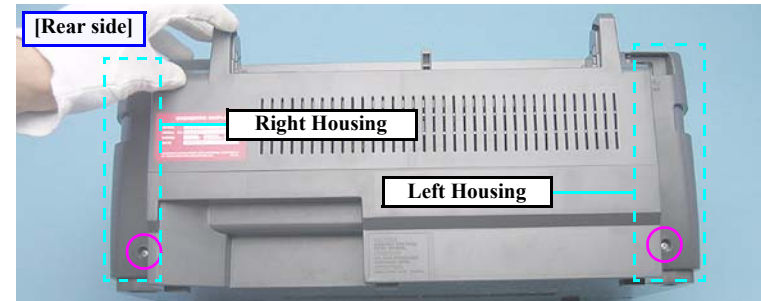



Figure 4-16. Removing the Right/Left Housings (1)

2. Insert a metal straightedge into the slit (ventilating opening) on the Right Housing and disengage the hook.
3. While pushing , disengage the two tabs, and slide the Right Housing rearward to remove it. (Refer to Fig.4-18)

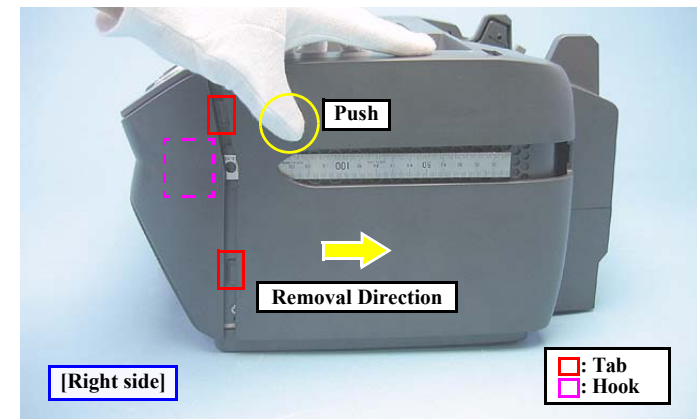

Figure 4-17. Removing the Right/Left Housings (2)

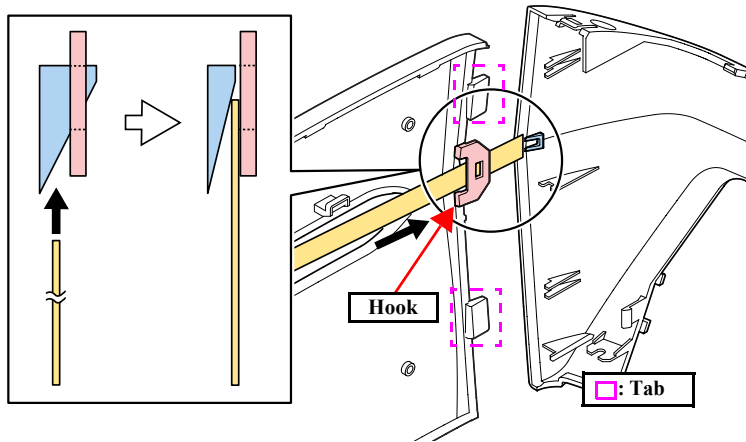

Figure 4-18. Disengaging the Hook and Tabs

4. Remove the Left Housing in the same manner.



Before screwing the Right Housing and Left Housing, make sure the two hooks on each housing shown below are properly inserted into the holes of the Upper Housing.

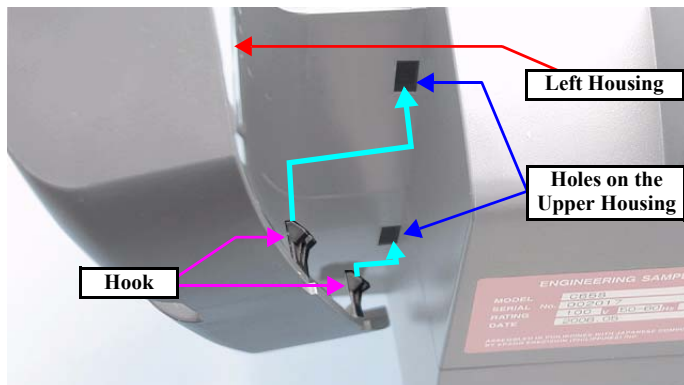



Figure 4-19. Reinstalling the Right/Left Housings

■ Removing the USB Housing

1. Push  part to disengage the hook and slide the USB Housing upward to remove it.

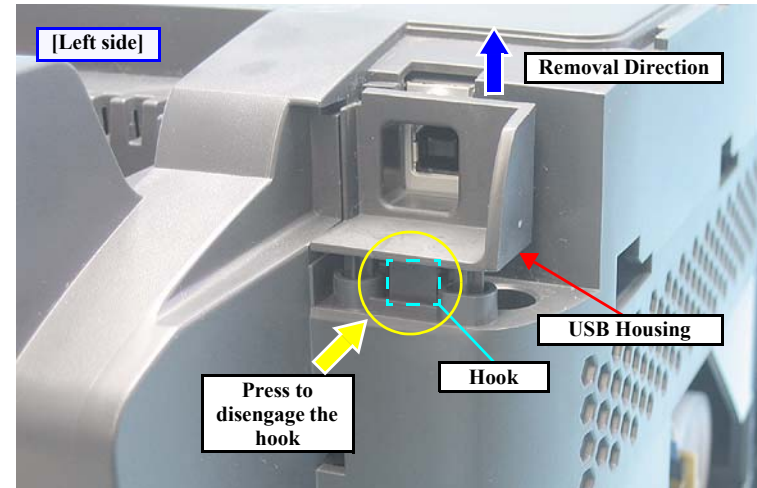

Figure 4-20. Removing the USB Housing



4.2.5 Upper Housing

- Parts/Components need to be removed in advance

Paper Support / Printer Cover / Front Cover / Right Housing / Left Housing / USB Housing

- Removal procedure

1. Remove eight screws.

- Screw : C.B.P. M3x10 (tightening torque: 5-7 kgf.cm, silver)
 - Screw : C.B.P. M3x10 (tightening torque: 5-7 kgf.cm, black)
 - Screw : C.B.P. M3x10 (tightening torque: 5-7 kgf.cm, black, diagonally mounted)
- (The numbers shown in the figure indicate the order of tightening the screws.)

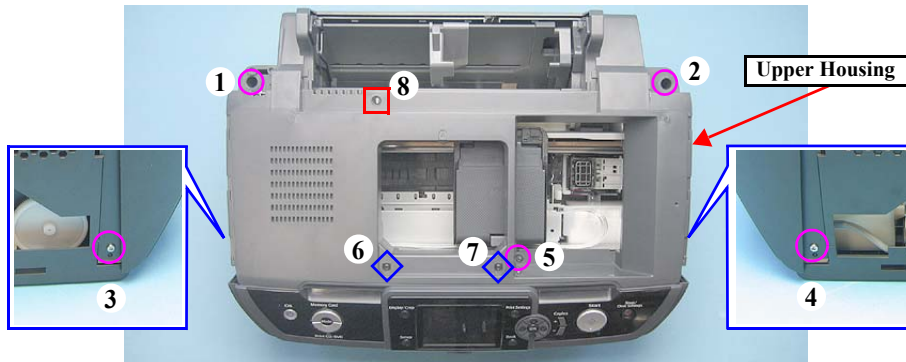



Figure 4-21. Removing the Upper Housing (1)

2. Pull the left and right  of the Upper Housing to disengage the two positioning holes of the housing from the guide pins of the Lower Housing, and remove the Upper Housing avoiding contact with the ASF Unit.

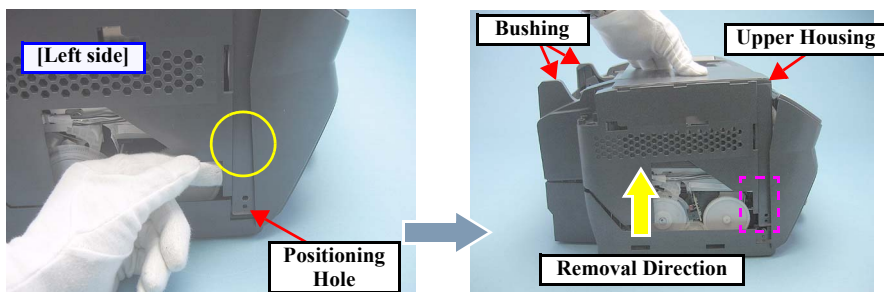



Figure 4-22. Removing the Upper Housing (2)



- Be careful not to let the cables get caught under the Upper Housing at the position indicated with  in Fig.4-22.
- Tighten the screws in the order given in Fig.4-21.
- (6), (7), (8) screws are black, and (6), (7) screws are mounted diagonally toward the rear side of the printer. Keep that in mind when removing/attaching the screws.

4.2.6 Panel Unit

- Parts/Components need to be removed in advance
Paper Support / Printer Cover / Front Cover / Right Housing / Left Housing / USB Housing / Upper Housing
- Removal procedure

CAUTION **Take extra care to avoid injury from sharp metal edges. Before starting, see the page given below to check the dangerous edges.**
 •“4.1.8 Sharp Metal Edges (Danger!)” (p.62)

1. Disconnect the two FFCs from CN3 and CN4 connectors on the Main Board. (disconnect CN5 only for the R260/R265/R270)

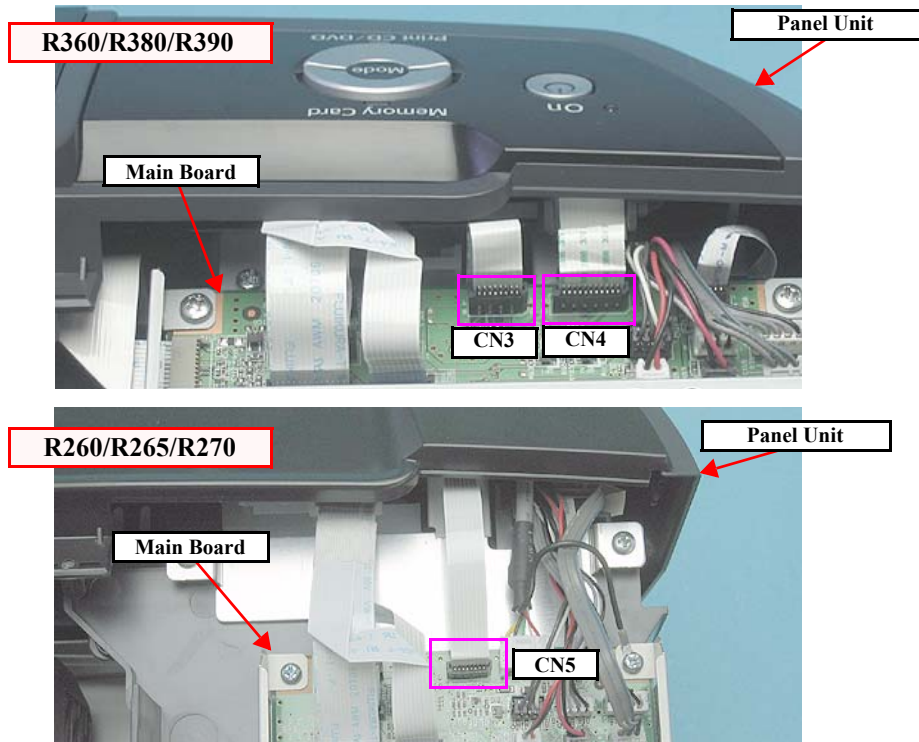

Figure 4-23. Removing the Connectors (Panel Unit)

2. Slide the Panel while pulling it upwards and disengage the two hooks. If the hooks do not disengage, insert a flathead screw driver into the hole of the Front Housing positioning rib from the backside of the panel, to disengage the two hooks (□).
3. Slide the Panel Unit upward to remove it.

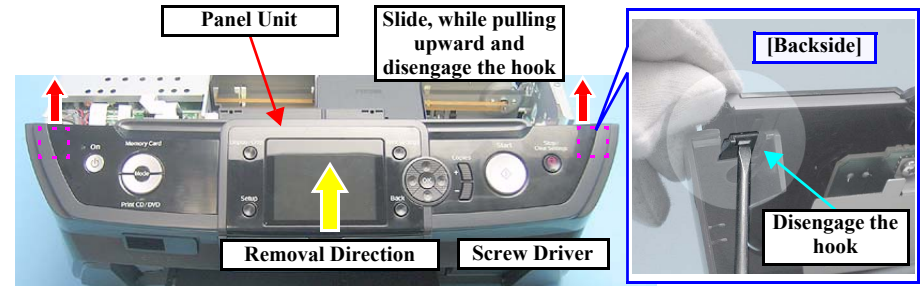

Figure 4-24. Removing the Panel Unit



When reinstalling the Panel Unit, engage the four tabs by sliding the unit downward, and insert the two ribs beside left and right hooks into grooves until the hooks are securely engaged.

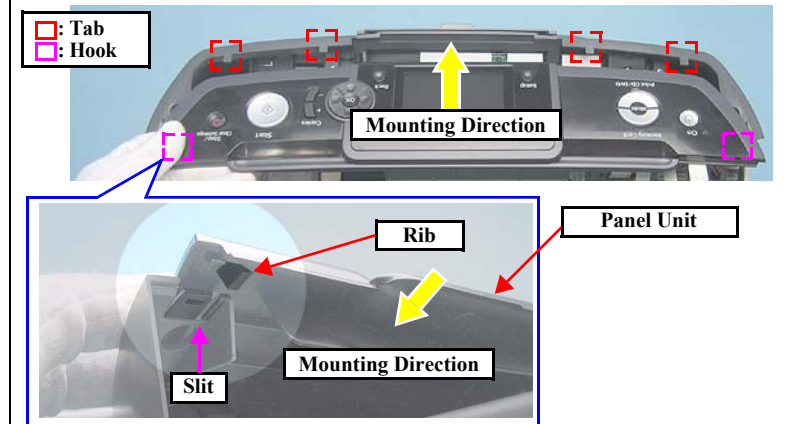



Figure 4-25. Reinstalling the Panel Unit

4.2.7 EMI Frame / Waste Ink Tray

- Parts/Components need to be removed in advance
Paper Support / Printer Cover / Front Cover / Right Housing / Left Housing / USB Housing / Upper Housing / Panel Unit
- Removal procedure

CAUTION

Take extra care to avoid injury from sharp metal edges. Before starting, see the page given below to check the dangerous edges.
 •“4.1.8 Sharp Metal Edges (Danger!) (p.62)”

CHECK POINT

 See the section given below on how to unlock the carriage.
 •“4.1.7 How to Unlock the Carriage (p.62)”

- EMI Frame Removal
- 1. Unlock the carriage and move the CR Unit to the center.
- 2. Remove the two screws and remove the EMI Frame.
 - Screw  : C.B.S. M3x6 (tightening torque: 7-9 kgf.cm)

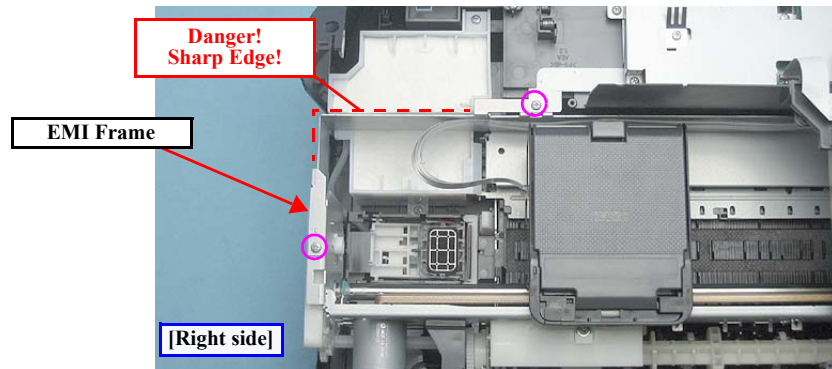

Figure 4-26. Removing the EMI Frame



- Follow the procedure below to install the EMI Frame.
- 1. Insert (1) portion between the Shield Plate and the Main Frame. (R360/R380/R390 only)
- 2. Insert the bottom edge of the EMI Frame into the notch of the Waste Ink Tray.
- 3. Insert the positioning hole (2) over the guide pin on the main frame.
- 4. Tighten the screws in the order of (1) and (2).

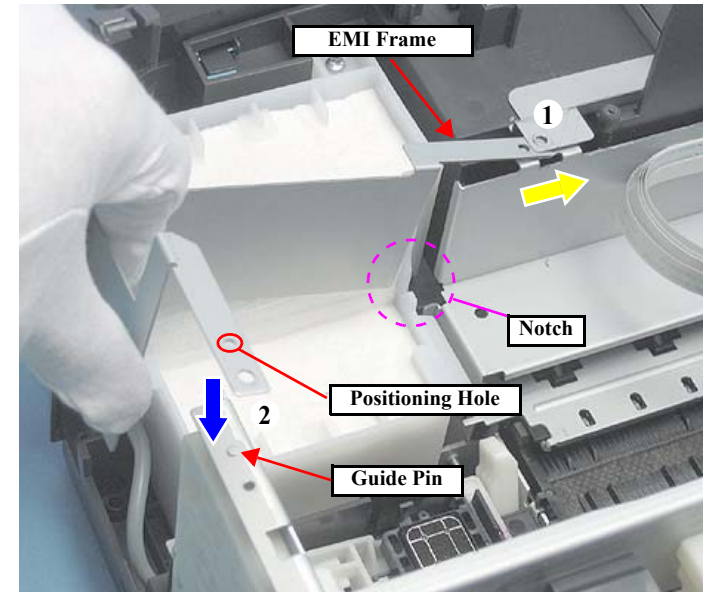

Figure 4-27. Reinstalling the EMI Frame

■ Waste Ink Tray Removal



- When removing the Waste Ink Tray, take extra care not to spill ink and contaminate the printer and surroundings.
- Do not pull the Waste Ink Tray too much to remove it, as it is connected to the Ink System with the Waste Ink Tube.
- Extra care must be exercised not to scratch or damage the Waste Ink Tube.
- The EJ Frame Spring of the EJ Frame Assy is located beneath the Waste Ink Tray. (○ in Fig.4-31 shows the location.) The spring may come off during removing the Waste Ink Tray. If it does, be sure to reattach it as shown below.

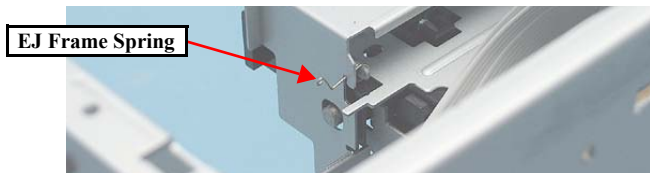

Figure 4-28. Cautions on removing the Waste Ink Tray



- When removing the Waste Ink Tray, remove it through the cutout of the Housing carefully so as not to pull the tube too much. The tray should be placed as shown below when it is pulled out through the cutout.
- When the Waste Ink Tray does not need to be replaced, you do not have to remove the Waste Ink Tube from the tray. Proceed to the next step leaving the Waste Ink Tray beside the printer mechanism as shown below.

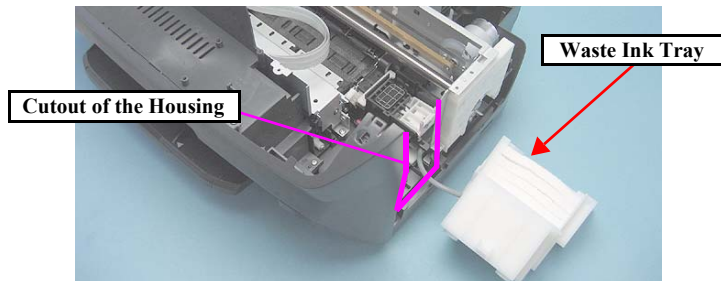

Figure 4-29. Handling of the Waste Ink Tray

1. Remove the two screws and remove the Waste Ink Tray.
 - Screw ○ : C.B.P. M3x10 (tightening torque: 5-7 kgf.cm)
(The numbers shown in the figure indicate the order of tightening the screws.)

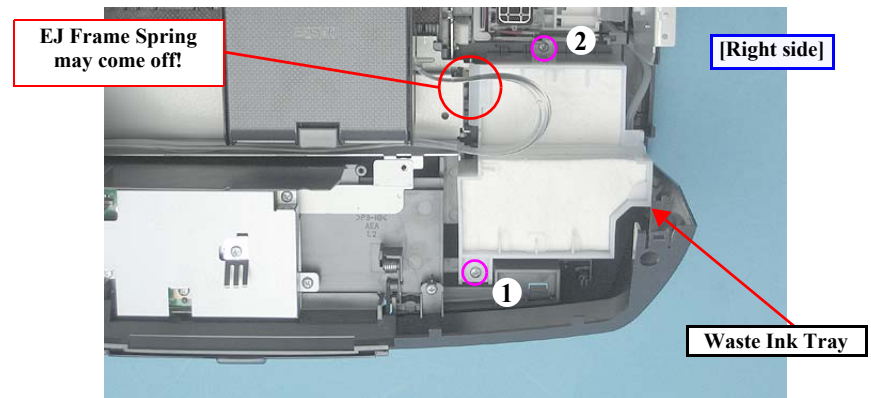

Figure 4-30. Removing the Waste Ink Tray (1)

2. Disconnect the Waste Ink Tube from the Waste Ink Tray with your hands.

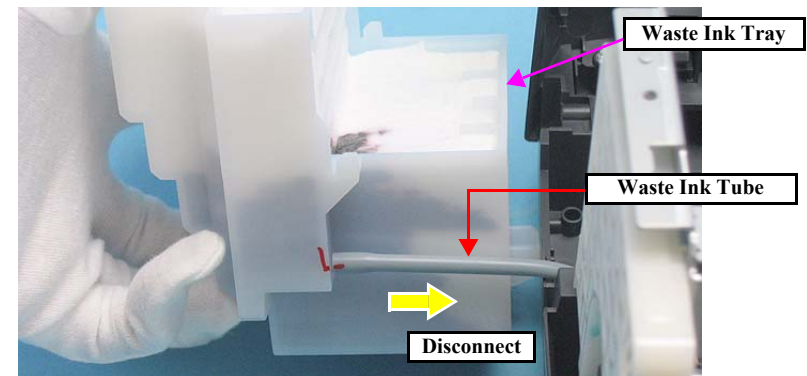

Figure 4-31. Removing the Waste Ink Tray (2)



- Wipe off any ink on the joint portion of the Waste Ink Tube before reconnecting the tube. Ink on the joint portion makes the tube likely to get disconnected.
- Insert the Waste Ink Tube until its leading edge reaches the point where the shaft of the Waste Ink Tray starts to widen as shown below.

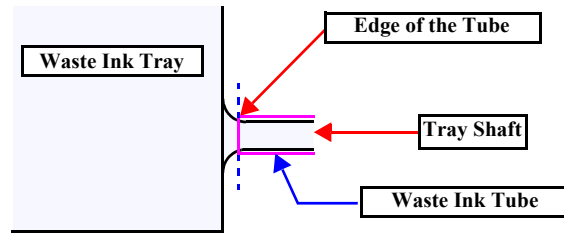

Figure 4-32. Cautions of installing the Waste Ink Tray

- Tighten the screws in the order given in Fig.4-30.

4.2.8 Right Front Housing / Left Front Housing

- Parts/Components need to be removed in advance
Paper Support / Printer Cover / Front Cover / Right Housing / Left Housing / USB Housing / Upper Housing / Panel Unit / EMI Frame / Waste Ink Tray
- Removal procedure



Take extra care to avoid injury from sharp metal edges. Before starting, see the page given below to check the dangerous edges.
 •“4.1.8 Sharp Metal Edges (Danger!)” (p.62)

1. Disengage the two tabs at (1) portion (inside the Front Housing) by lightly pushing down the tip of the tabs. First disengage the lower tab and then disengage the upper one.
2. Pull the Right Front Housing toward you to remove it.
3. Disengage the two tabs at (2) portion in the same manner, and remove the Left Front Housing

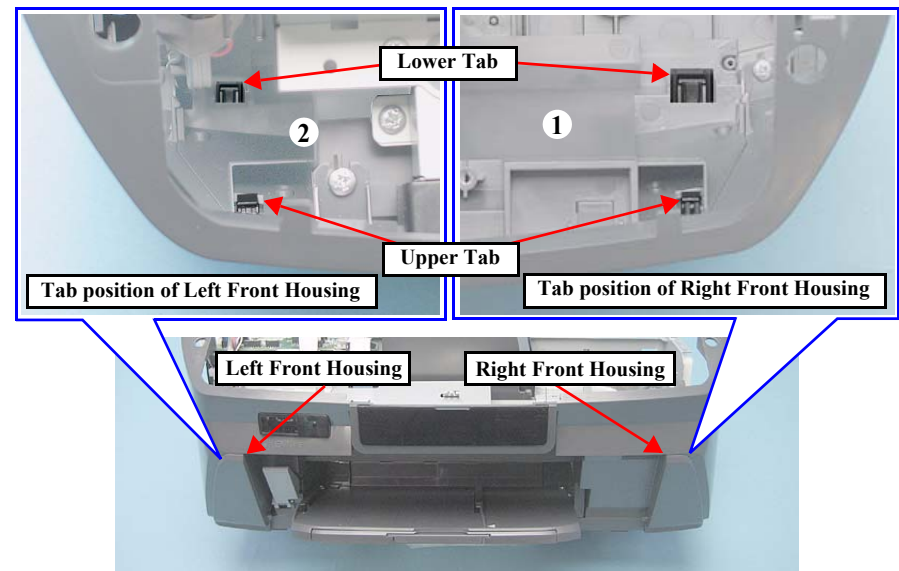

Figure 4-33. Removing Left/Right Front Housings (1)

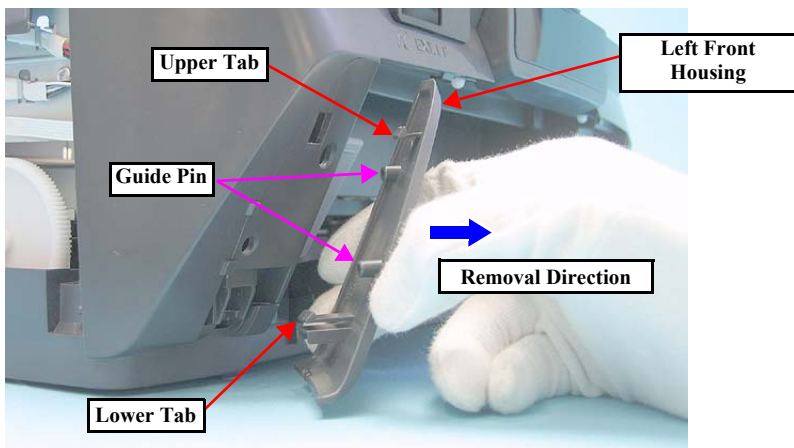

Figure 4-34. Tabs of the Right/Left Front Housings

4.2.9 Front Housing

- Parts/Components need to be removed in advance
Paper Support / Printer Cover / Front Cover / Right Housing / Left Housing / Upper Housing / Panel Unit / EMI Frame / Waste Ink Tray / Right Front Housing / Left Front Housing
- Removal procedure

CHECK POINT



The Front Housing differs in shape between the R260/R265/R270 and the R360/R380/R390, however, the removal procedure itself is almost the same. Here, the procedure is illustrated using the R360/R380/R390.

■ Front Housing Removal

1. Hold the one end of the Torsion Spring of the Middle Housing, release it from the slit of the rib, and remove the Torsion Spring from the pin. (R360/R380/R390 only)

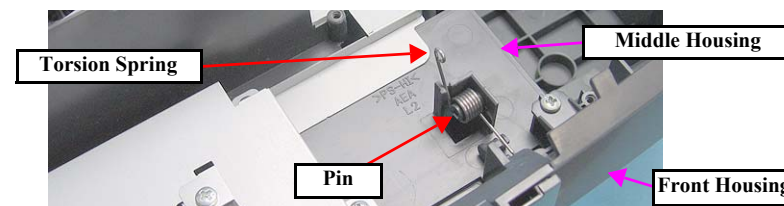



Figure 4-35. Removing the Torsion Spring (R360/R380/R390 only)

2. Remove the four screws.
 - Screw  : C.B.P. M3x10 (tightening torque: 5-7 kgf.cm)
(The numbers shown in the figure indicate the order of tightening the screws.)

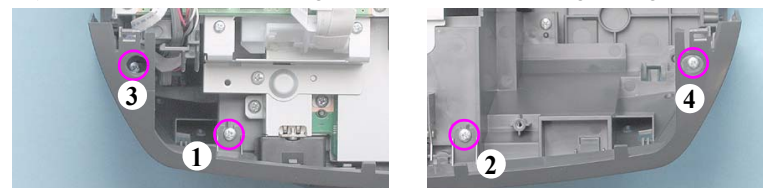

Figure 4-36. Removing the Front Housing (1)

3. With a flathead screwdriver or similar tool, disengage the two tabs on the inner left and right sides.
4. From the bottom side of the Printer, insert a flathead screw driver into the hole of the Lower Housing to disengage the two tabs. (With R260/R265/R270, the tabs can be disengaged from the upper side of the Middle Housing.)

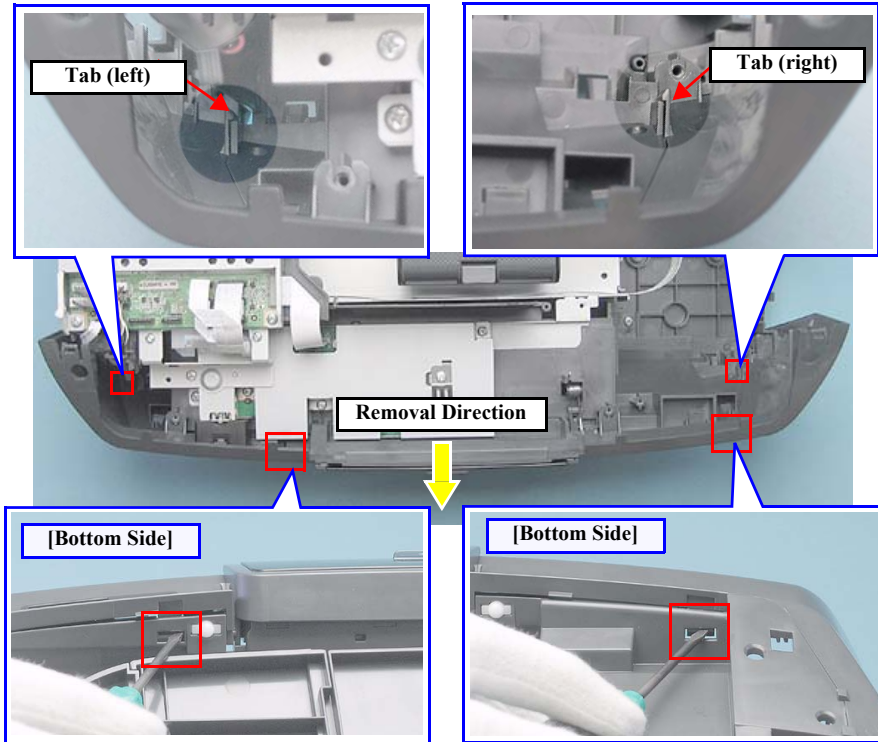

Figure 4-37. Removing the Front Housing (2)



When removing the Front Housing, make sure to remove it in the specified direction without tilting it, otherwise the tip of the bottom ribs on both left and right sides may be scratched heavily or broken.

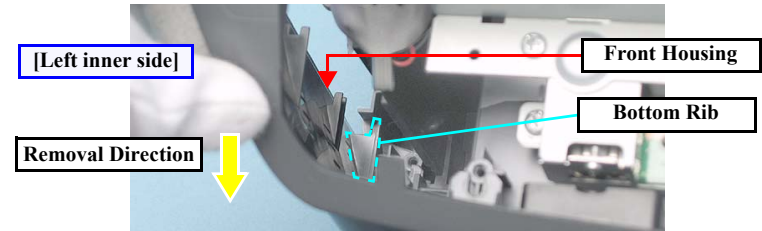

Figure 4-38. Caution as to Removing the Front Housing

5. Slide the Lower Housing toward you carefully avoiding the two bottom ribs, and remove the Lower Housing.
 - Removing the Slot Cover (R360/R380/R390 only)
 1. Disengage the two tabs [] , and remove the Slot Cover.



Figure 4-39. Removing the Slot Cover



- Install the Front Housing following the steps below
- 1. Install the Slot Cover. (R360/R380/R390 only)
- 2. With the two hooks on the inner bottom, insert the right followed by the left.
- 3. Push the two ○ parts and insert the hooks firmly.

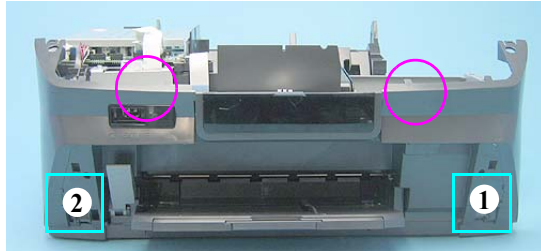

Figure 4-40. Reinstalling the Front Housing (1)

- 4. Attach the Torsion Spring to the Slot Cover. (R360/R380/R390 only)
- 5. While pressing the Front Housing with your thumb holding the Middle Housing with your other fingers as shown below, secure the screw (1) on the top left.
- 6. While pressing the Front Housing with your thumb holding the Front Frame with your other fingers, secure the screw (2) on the top right.

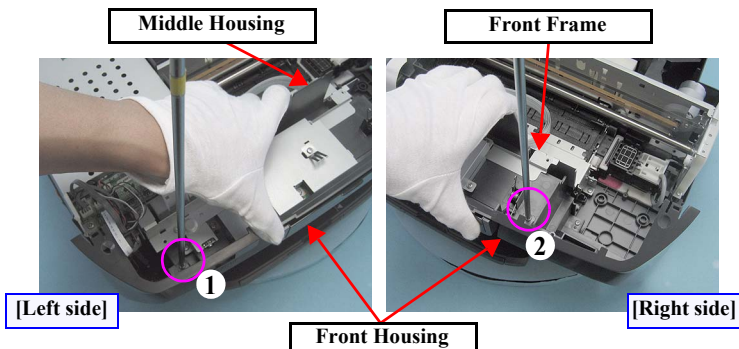

Figure 4-41. Reinstalling the Front Housing (2)



- 7. While pressing the Front Housing with your thumb holding the Middle Housing with your other fingers as shown below, secure the screw (3) on the bottom left.
- 8. While pressing the Lower Housing with your thumb holding the Front Housing with your other fingers as shown below, secure the screw (4) on the bottom right.

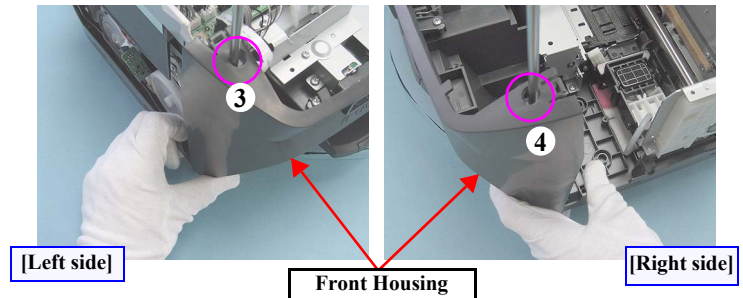

Figure 4-42. Reinstalling the Front Housing (3)

- After installing the Front Housing, make sure that the Front Housing is securely attached with no misalignment.
- When reinstalling the Torsion Spring, attach one end (1) of the spring to the cutout of the Slot Cover, insert the coiled part over the shaft of the Middle Housing, and attach the other end (2) to the cutout of the Middle Housing. (R360/R380/R390 only)

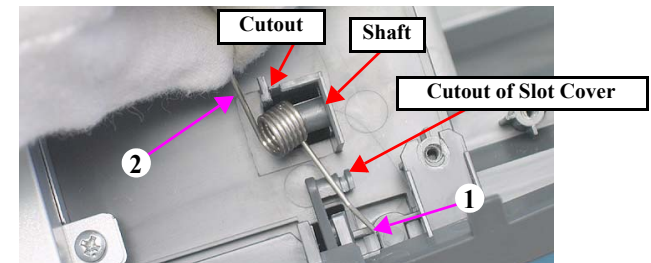

Figure 4-43. Reinstalling the Torsion Spring (R360/R380/R390 only)

- After reinstalling the Torsion Spring, check that the Slot Cover opens and closes smoothly. (R360/R380/R390 only)

4.3 Removing Control Boards



4.3.1 Removing the USB Board (R260/R265/R270 only)

- Parts/Components need to be removed in advance
 - All exterior parts/components
- USB Board removal

CHECK POINT



- R260/R265/R270 are equipped with a USB Board. Remove the USB Board before removing the Main Board. Refer to [R260/R265/R270 & R360/R380/R390 Disassembly Flowchart\(p.64\)](#)
- Refer to the Orientation Definition below for the directions indicated in the following procedures.
 - “4.1.6 Orientation Definition (p.61)”

1. Remove the piece of acetate tape and remove the USB connector cable from the cable retainer.
2. Disconnect the USB cable from the connector.
3. Remove the screw and remove the GND cable.
4. Remove the three screws.
 - Screw  : C.B.P. M3x10 (tightening torque: 5-7 kgf.cm)
 - Screw  : C.B.S. M3x6 (tightening torque: 5-7 kgf.cm)
 (The numbers shown in the figure indicate the order of tightening the screws.)

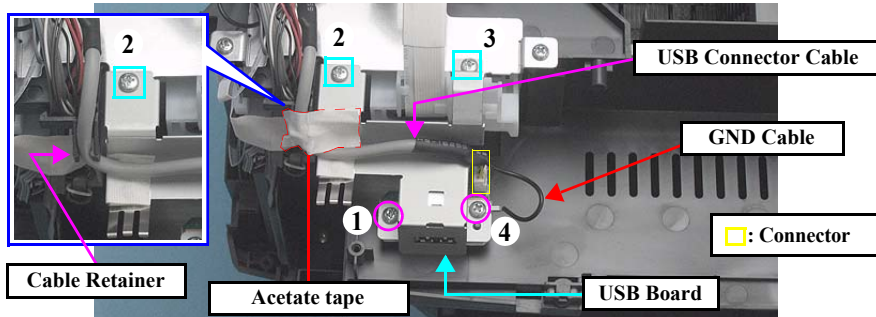

Figure 4-44. Removing the USB Board

5. Remove the USB Shield Plate and the USB Board.

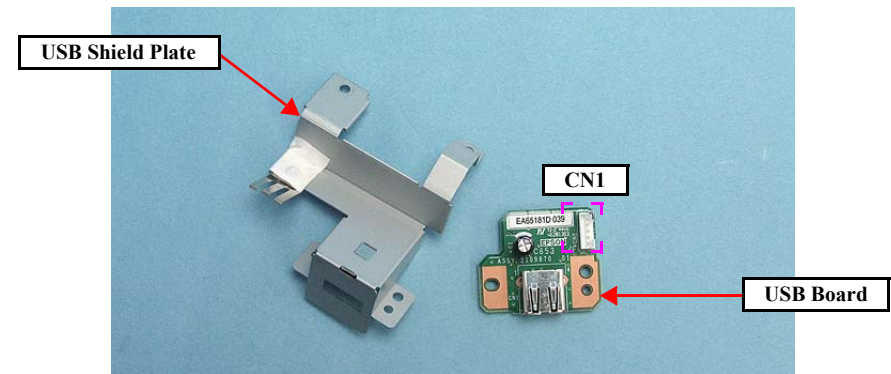

Figure 4-45. Disassembling the USB Board

- FFC Holder removal

1. Peel off the acetate tape, and disengage all the cables and Ferrite Core from the FFC Holder.
2. Release the Head FFC from the two tabs of the FFC Holder.

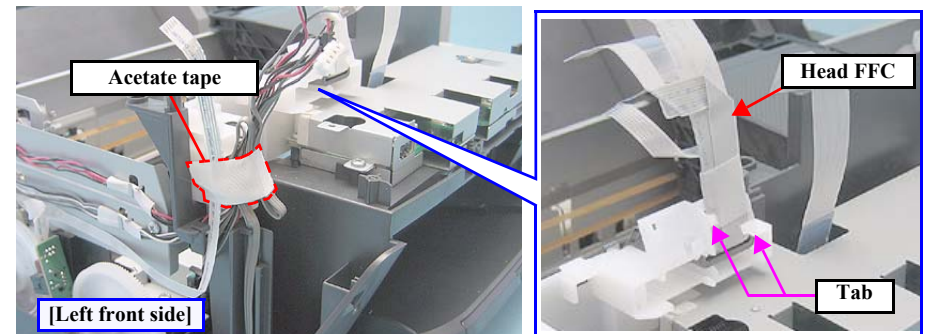

Figure 4-46. Removing the Cables

- From the rear side, push the positioning pin out with a screw driver or similar tool, and slide the FFC Holder upward to remove it from the Middle Housing.

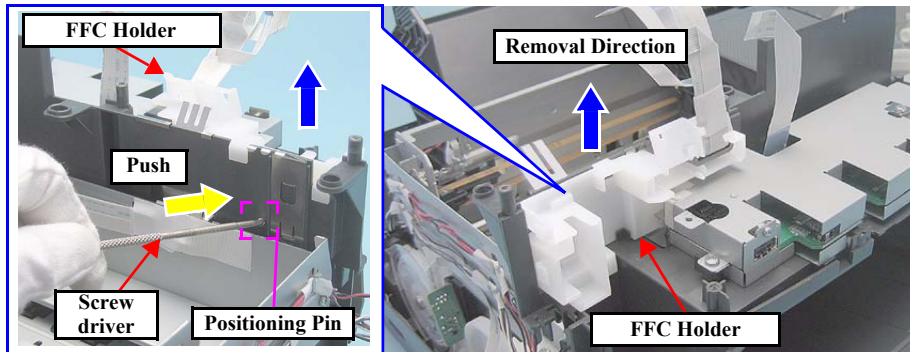

Figure 4-47. Removing the FFC Holder (1)

- Straighten the fold of the Head FFC, and remove the FFC Holder pulling the FFC out from the Ferrite Core.

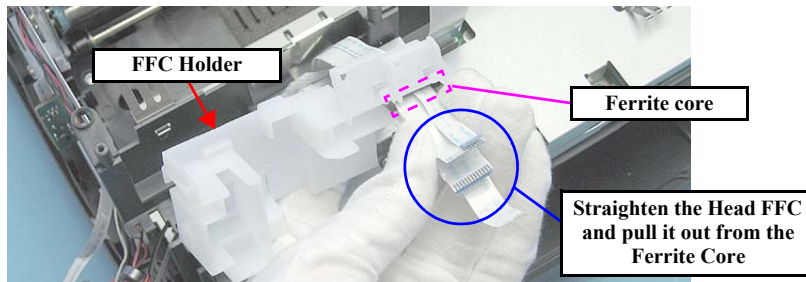

Figure 4-48. Removing the FFC Holder (2)



When installing the FFC Holder, make sure to secure it with the three hooked tabs and insert the positioning pin shown in Fig.4-47.

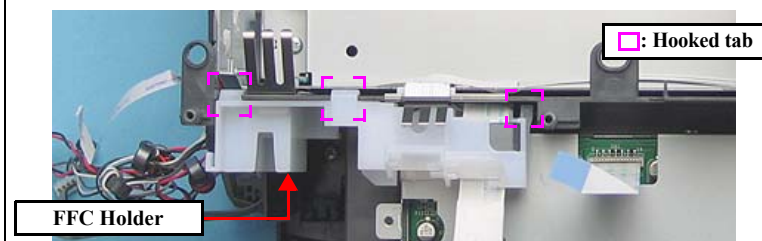

Figure 4-49. Reinstalling the FFC Holder



- When putting the Head FFC through the Ferrite Core, first straighten the fold of the pair of two FFCs, then put the five FFCs through the Ferrite Core one by one taking care not to damage them. Then, route the FFCs after folding the pair of two FFCs as they were (fold at -- shown in the figure).

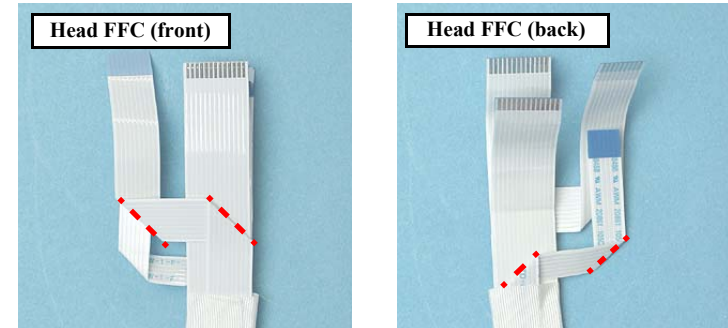

Figure 4-50. Routing the Head FFC (2)

- Screw the USB Board in the order given in Fig.4-44.
- When screwing the USB Board, secure the GND Cable of the USB Cable together with the screw as shown in Fig.4-44.

4.3.2 Removing the Main Board Unit

- Parts/Components need to be removed in advance
 - All exterior parts/components / USB Board (R260/R265/R270 only)
- Removal procedure
 1. Disconnect all FFCs and connector cables from the Main board.
 2. Remove the all cables from the cable retainer on the Main Board.

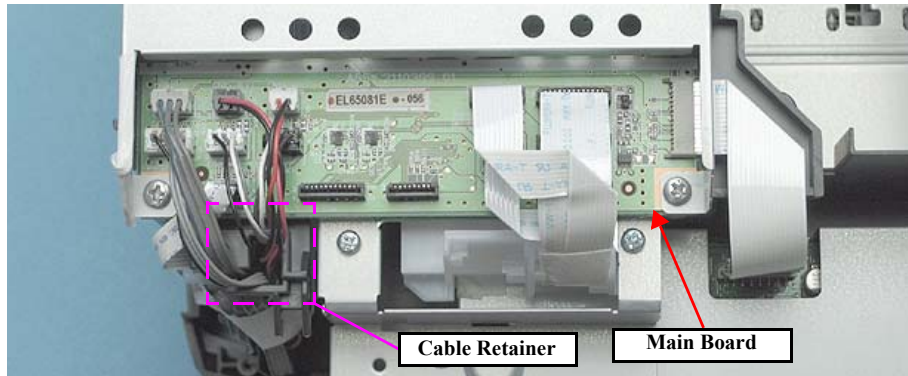

Figure 4-51. Removing the Cables (R360/R380/R390 Main Board)

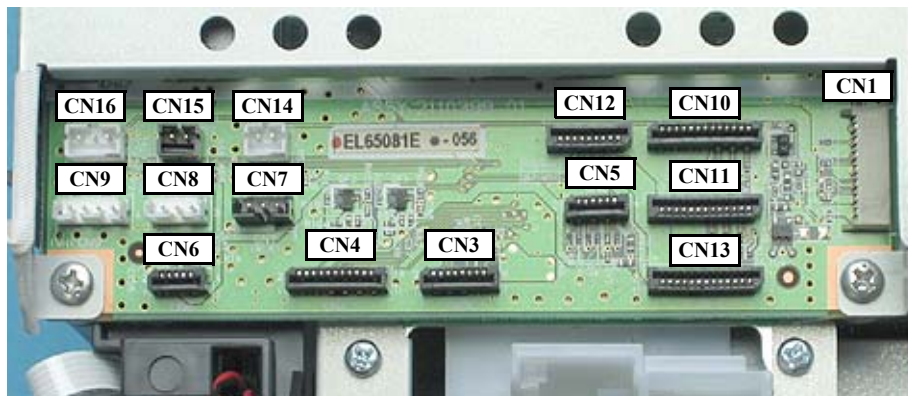

Figure 4-52. R360/R380/R390 Main Board



For R260/R265/R270, when removing the connector cables, also remove the GND Cable of the USB Connector Cable (CN2). This GND Cable is screwed together with the Shield Plate in part .

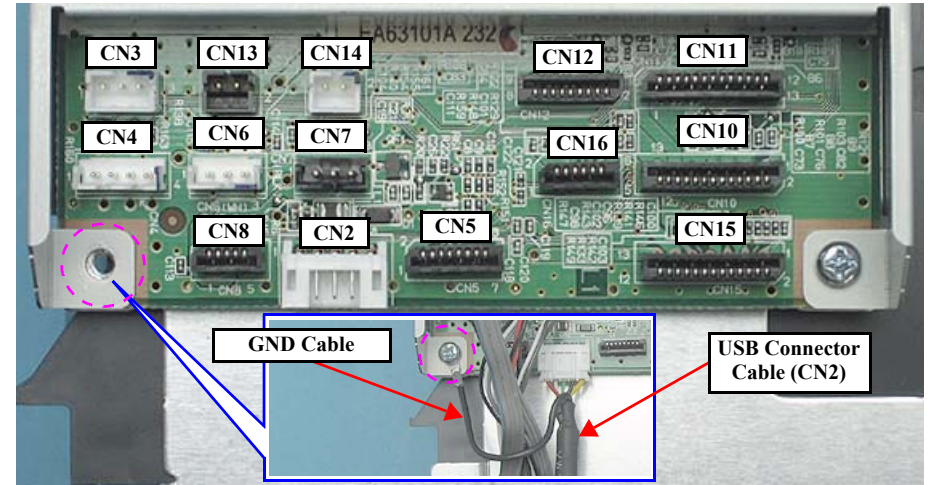





Figure 4-53. R260/R265/R270 Main Board

Table 4-5. List of Connectors and their Destinations

CN No.		Color	Destination	Number of pins
R360/R380/R390	R260/R265/R270			
CN1	---	FFC	Card Board	15pin
---	CN2	White	USB Board	5pin
CN3	CN5	FFC	Panel Board	8pin
CN4	--	FFC	Panel Board	11pin
CN5	CN16	FFC	CR Encoder	6pin
CN6	CN8	FFC	PF Encoder	6pin
CN7	CN7	Black	APG Sensor	3pin
CN8	CN6	White	PE Sensor	3pin
CN9	CN4	White	CDR Guide Detection Assy	4pin
CN10	CN11	FFC	Printhead	13pin
CN11	CN10	FFC	Printhead	13pin
CN12	CN12	FFC	Printhead	9pin
CN13	CN15	FFC	CSIC	13pin
CN14	CN14	White	CR Motor	2pin
CN15	CN13	Black	PF Motor	2pin
CN16	CN3	White	Power Supply	3pin

3. Remove the four screws. (For R260/R265/R270, three screws  only)
 - Screw  (3 pcs.): C.B.P. M3x10 (tightening torque: 5-7 kgf.cm)
 - Screw  (1 pc.): C.P. M3x6 (tightening torque: 7-9 kgf.cm)
 (The numbers shown in the figure indicate the order of tightening the screws.)
4. Remove the Main Board. (R260/R265/R270 only)

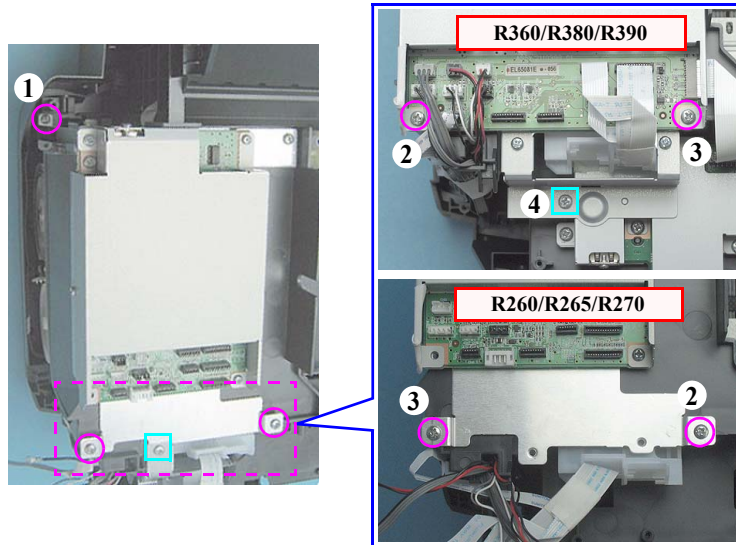

Figure 4-54. Removing the Main Board (1)

5. Remove the Main Board, taking extra care not to get the FFC caught on the opening of the CB Support Shield Plate. (R360/R380/R390 only)

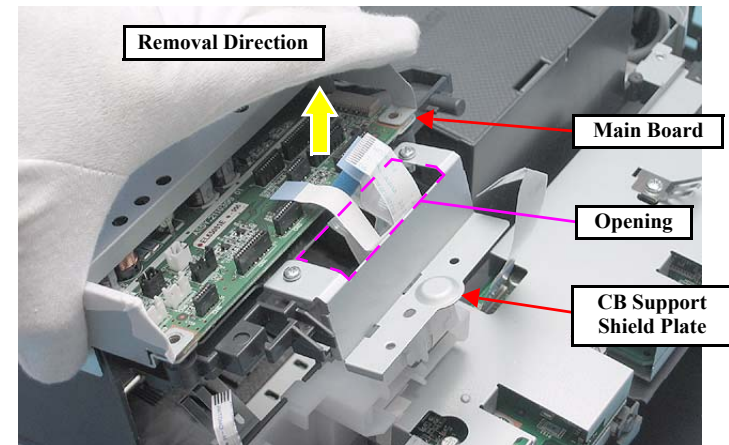

Figure 4-56. Removing the Main Board Unit (2)



The MB Frame deforms easily. Exercise care not to deform it while removing the Main Board.

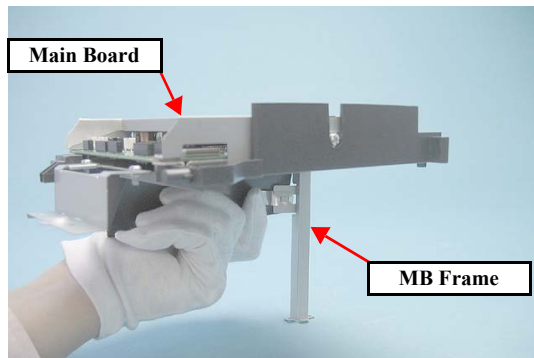

Figure 4-55. Cautions on Removing the Main Board Unit



- Install the Main Board Unit following the steps below.
- 1. Install the MB Frame to the the Lower Housing, and make sure that the Ground Plate MB contacts with the Main Frame. (Screw (1) in Fig.4-54)
- 2. Install the Main Board Unit screwing it in the order given in Fig.4-54.
- 3. Install the Main Board Unit to the MB Frame. (Fig.4-59)
- After installing the Main Board, check that the Ground Plate MB contacts with the Main Frame.

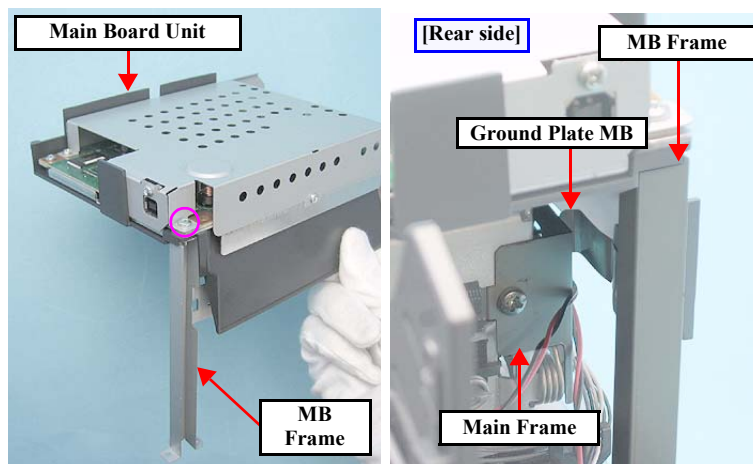

Figure 4-57. Reinstalling the Main Board Unit(1)

- Insert the left and right front screw holes of the Main Board Unit over the guide pins of the Middle Housing before screwing the unit.

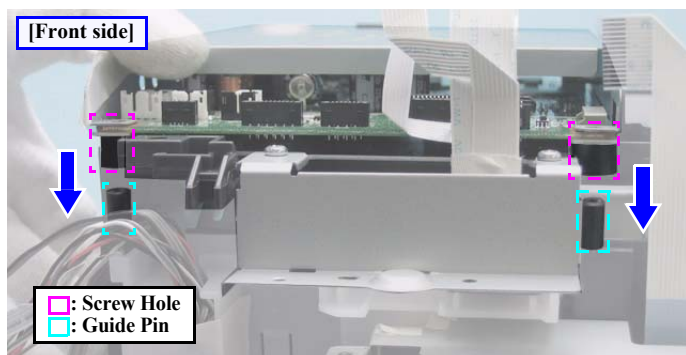

Figure 4-58. Reinstalling the Main Board Unit (2)

4.3.3 Disassembling the Main Board Unit

- Main Board Unit disassembly



The Main Board Unit differs in shape and etc. between the R260/R265/R270 and the R360/R380/R390, however, the removal procedure is almost the same. Here, the procedure is illustrated mainly using the R360/R380/R390 showing the difference as necessary.

1. Remove the screw and remove the MB Frame from the Main Board.
 - Screw ○ : C.B.S. M3x10 (tightening torque: 5-7 kgf.cm)

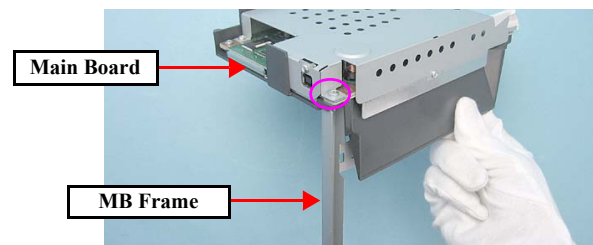

Figure 4-59. Removing the MB Frame

2. Remove the screw and remove the Main Board from the MB Cover.
 - Screw ○ : C.B.S. M3x10 (tightening torque: 7-9 kgf.cm)
3. Remove the two screws and remove the CB Support Shield Plate. (R360/R380/R390 only)
 - Screw □ : C.B.S. M3x8 (tightening torque: 7-9 kgf.cm)

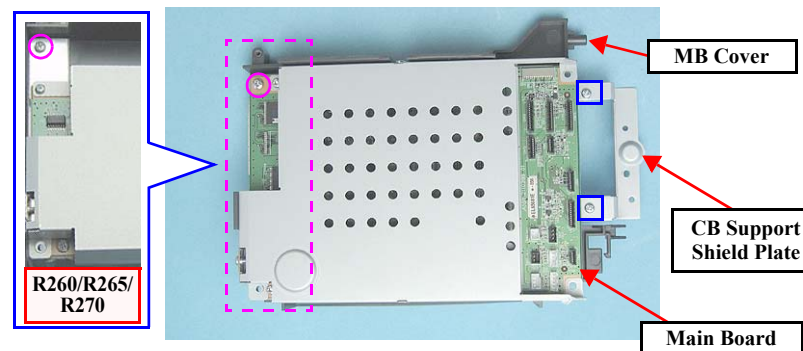



Figure 4-60. Removing the MB Cover/CB Shield Plate Support

4. Remove the Upper Shield Plate MB from the Main Board following the steps below.

■ For R360/R380/R390

Remove the four screws and remove the Shield Plate MB from the Main Board.

- Screw  : C.P.M3x6 (tightening torque: 5-7 kgf.cm)
 - Screw  : C.B.S. M3x8 (tightening torque: 5-7 kgf.cm)
- (The numbers shown in the figure indicate the order of tightening the screws.)

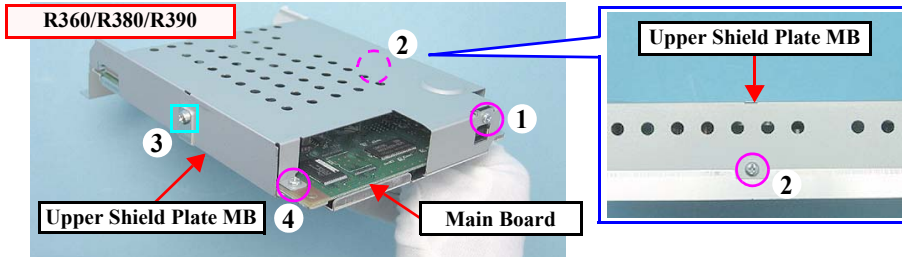



Figure 4-61. Removing the Upper Shield Plate MB (R360/R380/R390)

■ For R260/R265/R270

Remove the five screws and remove the Upper Shield Plate MB from the Main Board.

- Screw  : C.P. M3x6 (tightening torque: 5-7 kgf.cm)
 - Screw  : C.B.S. M3x8 (tightening torque: 5-7 kgf.cm)
- (The numbers shown in the figure indicate the order of tightening the screws.)

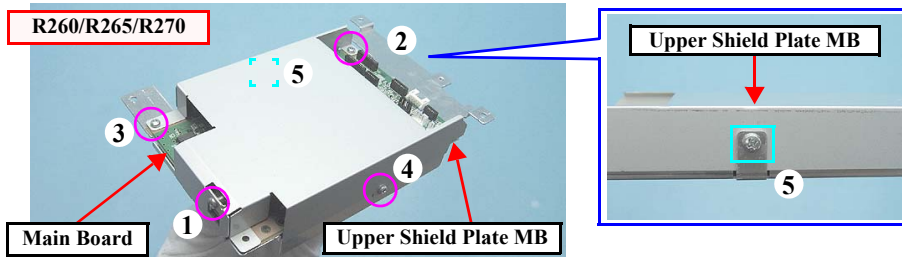



Figure 4-62. Removing the Upper Shield Plate MB (R260/R265/R270)

5. Remove the two screws and remove the Lower Shield Plate MB from the Main Board.

- Screw  : C.P. M3x10 (tightening torque: 5-7 kgf.cm)

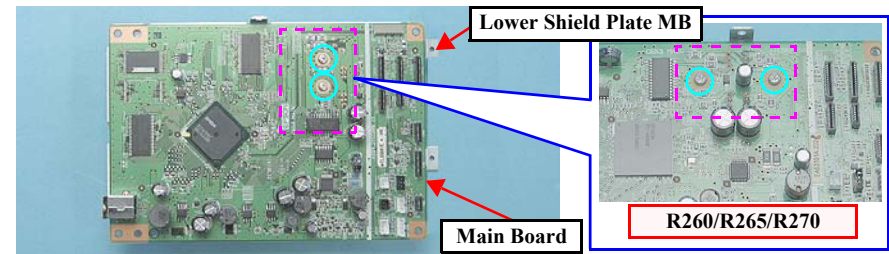

Figure 4-63. Removing the Main Board



- Screw the Upper Shield Plate MB of the R360/R380/R390 in the order given in Fig.4-61.
- Screw the Upper Shield Plate MB of the R260/R265/R270 in the order given in Fig.4-62.

4.3.4 Removing the Card Board (R360/R380/R390 only)

- Parts/Components need to be removed in advance

All exterior parts/components / Main Board Unit

- Card Board Removal



R360/R380/R390 are equipped with a Card Board. Remove the Card Board after removing the Main Board. Refer to R260/R265/R270 & R360/R380/R390 Disassembly Flowchart(p.64).

1. Remove the FFC Holder. (See [FFC Holder removal on page 76](#))
2. Remove the five screws and remove the Card Board.
 - Screw ○ : C.B.S. M3x10 (tightening torque: 5-7 kgf.cm)
(The numbers shown in the figure indicate the order of tightening the screws.)

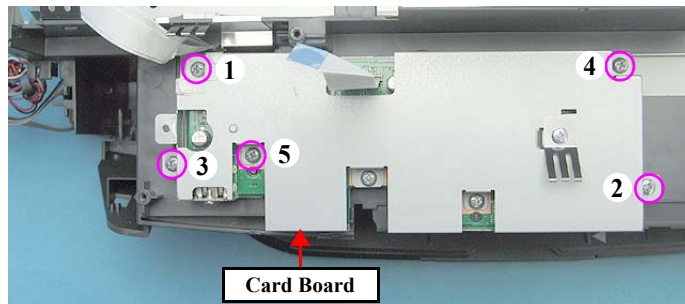

Figure 4-64. Removing the Card Board

- Card Board disassembly
 1. Disconnect the FFC from CN1 connector on the Card Board.
 2. Remove the screw and remove the Ground Plate CB.
 - Screw ○ : C.B.S. M3x6 (tightening torque: 5-7 kgf.cm)

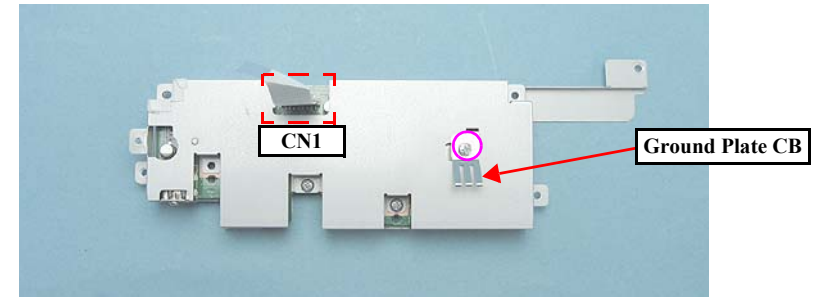

Figure 4-65. Card Board Disassembly



To match the FFC to the position of the Ferrite Core, twist and fold the Head FFC as shown in the figure, then route it through the Ferrite Core.

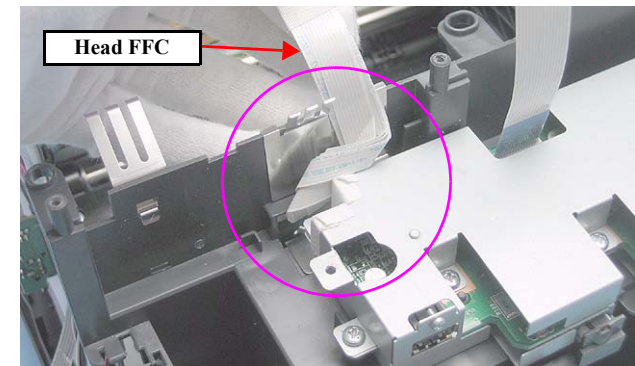

Figure 4-66. Routing the Head FFC (1)

- Screw the Card Board in the order given in [Fig.4-64](#).

4.3.5 Disassembling the Panel Unit

□ Panel Board removal



Be careful not to scratch or damage the exterior surface (coated or decorative laminated parts) during disassembly and reassembly.



Since the R260/R265/R270 are not equipped with a LCD panel, the removal procedure of the Panel Board differs from that of the R360/R380/R390. The procedure for the R260/R265/R270 is given on the page below.

• [Removing the Panel Board \(for R260/R265/R270\) on page 84](#)

■ Removing the Right/Left Laminated Panels (R360/R380/R390 only)

1. Disengage the four hooks on the rear side of the Panel Unit.
2. Push  section of the Left Laminated Panel as indicated with the arrow to disengage the tabs, and remove it.
3. Remove the Right Laminated Panel in the same manner.

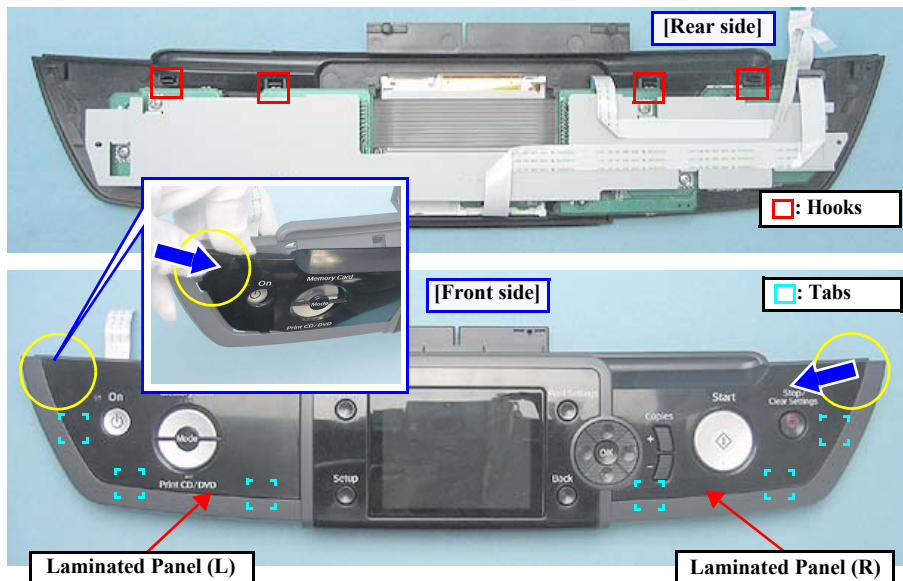

Figure 4-67. Removing the Left/Right Laminated Panels

□ Removing the Panel Board (for R360/R380/R390)

1. Peel off the acetate tape.
2. Disengage the Ferrite Core from the hook.

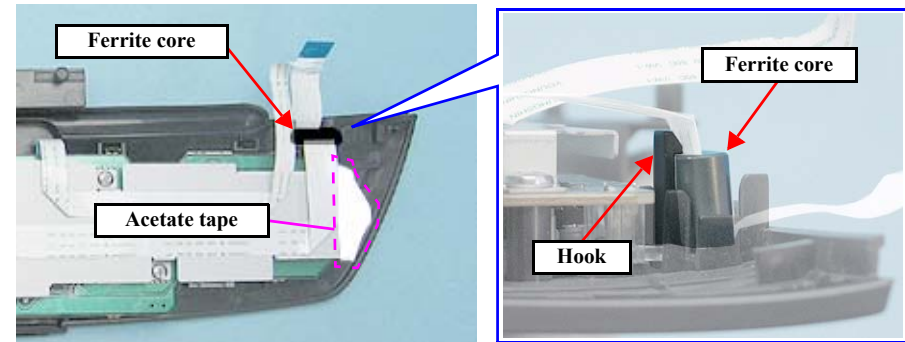



Figure 4-68. Removing the Panel Board (1)

3. Disconnect the FFCs from CN1 connector on the Panel Board and CN1 connector on the LCD Board.
4. Remove the six screws, taking care not to damage the cables connecting the two Panel Boards, remove the Shield Plate PNL in the direction of the arrow.
 - Screw : C.B.P. M3x10 (tightening torque: 5-7 kgf.cm)

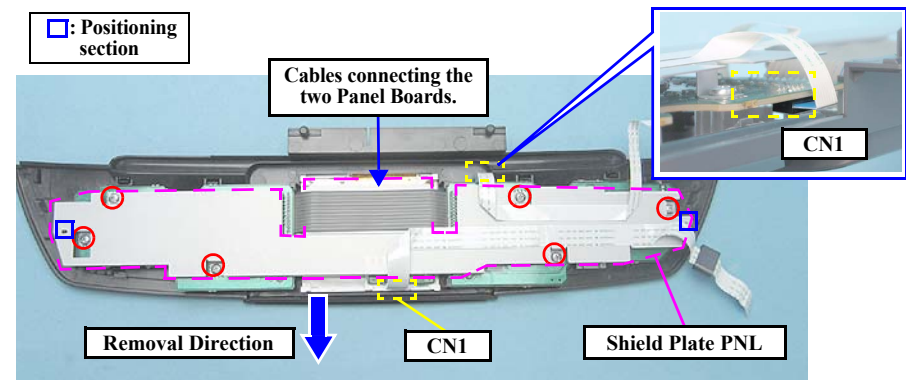





Figure 4-69. Removing the Panel Board (2)

5. Remove the screw and remove the Panel Board.
 - Screw : C.B.P. M3x10 (tightening torque: 5-7 kgf.cm)
 - Positioning Hole:  /Rib: 

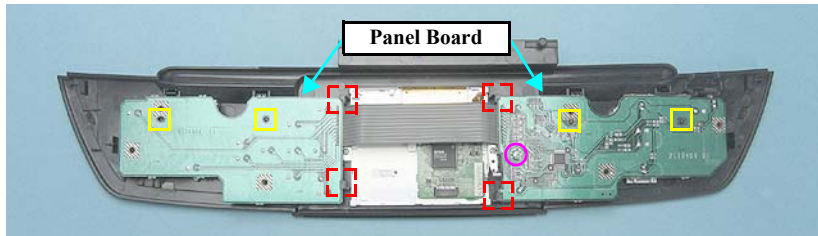



Figure 4-70. Removing the Panel Board (3)

6. Remove two screws and remove the LCD Panel and the Ground Plate LCD.
 - Screw : C.B.P. M2x6 (tightening torque: 2-3 kgf.cm)

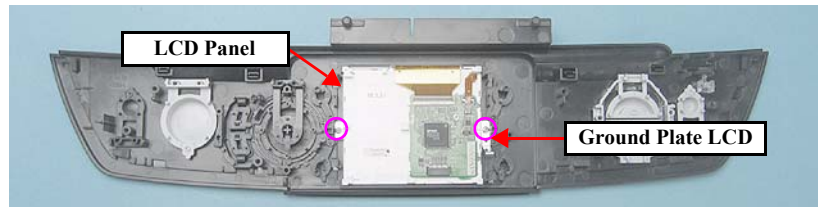

Figure 4-71. Removing the LCD Panel

7. Remove the SW Button (1) to (9) and the LED Light Guide Plate.

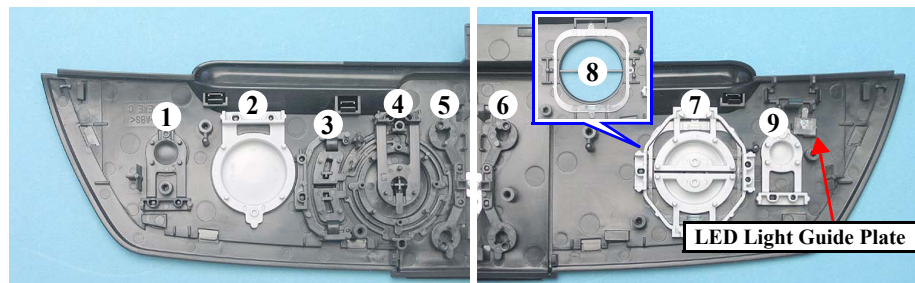



Figure 4-72. Removing the SW Buttons

8. Peel off the double-sided tape and remove the two FFCs from the Shield Plate PNL.
 - Double-sided tape: 

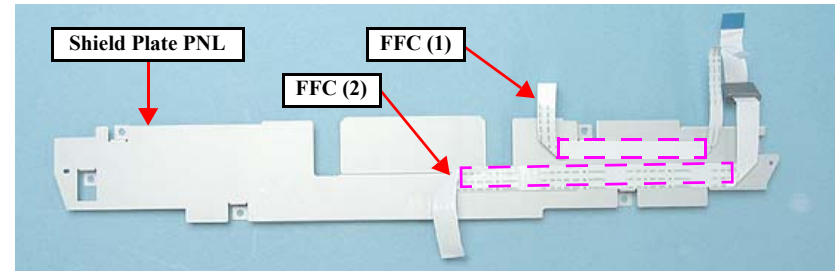

Figure 4-73. Removing the FFC

□ **Removing the Panel Board (for R260/R265/R270)**



1. Remove the four screws and disengage the hook () and remove the Panel Board Assy.
 - Screw : C.B.P. M3x8 (tightening torque: 7-9 kgf.cm)
(The numbers shown in the figure indicate the order of tightening the screws.)



Figure 4-74. Removing the Shield Plate PNL (R260/R265/R270)

2. Disconnect the FFC from CN1 connector on the Panel Board.
3. Remove two screws and remove the Panel Board from the Shield Plate PNL.
 - Screw : C.B.S. M3x6 (tightening torque: 4-6 kgf.cm)
(The numbers shown in the figure indicate the order of tightening the screws.)

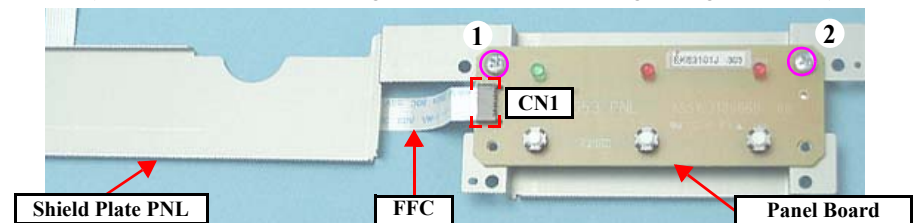

Figure 4-75. Removing the Panel Board (R260/R265/R270)

4. Remove the SW Button (1)(2)(3) and the LED Light Guide Plate.

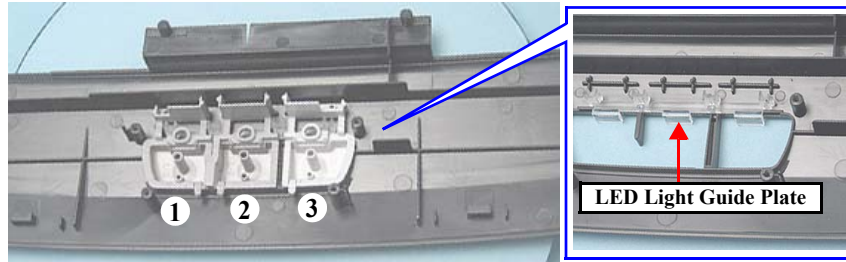



Figure 4-76. Removing the SW Buttons (R260/R265/R270)

5. Peel off the double-sided tape and remove the two FFCs from the Shield Plate PNL.

- Double-sided tape: 

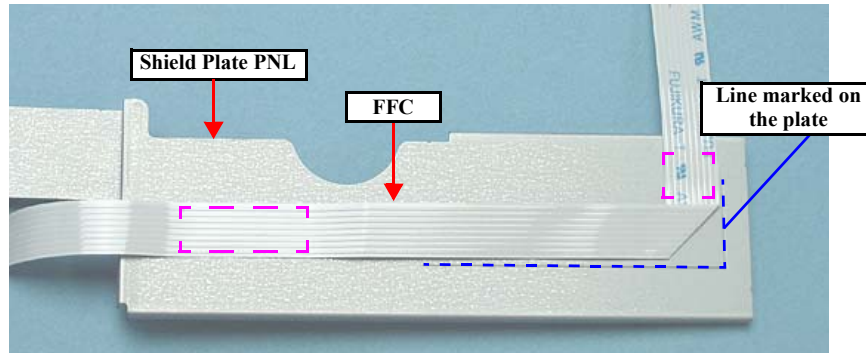

Figure 4-77. Removing the FFC (R260/R265/R270)



- For the R260/R265/R270, when installing the FFC to the Shield Plate PNL, align the FFC edges with the lines marked on the plate as shown in Fig.4-77, and secure it with double-sided tape. When screwing the Panel Board Assy, tighten the screws in the order given in Fig.4-74.
- For the R260/R265/R270, screw the Panel Board in the order given in Fig.4-75.



- When attaching the SW Buttons, insert their guide pin into the corresponding positioning hole firmly. After installing the Shield Plate PNL, check the buttons for clicking operability by pressing each of them.

Following instructions are for R360/R380/R390 only

- When installing the LCD Panel, check that the inner side of the LCD Cover is free of dust or dirt.
- Install the Shield Plate PNL putting it under the cables connecting the two Panel Boards.
- When installing the FFC (1) to the Shield Plate PNL, align the FFC edges with the line marked on the panel, and secure it with double-sided tape. And when installing the FFC (2), fold the FFC and secure it with double-sided tape as shown below.

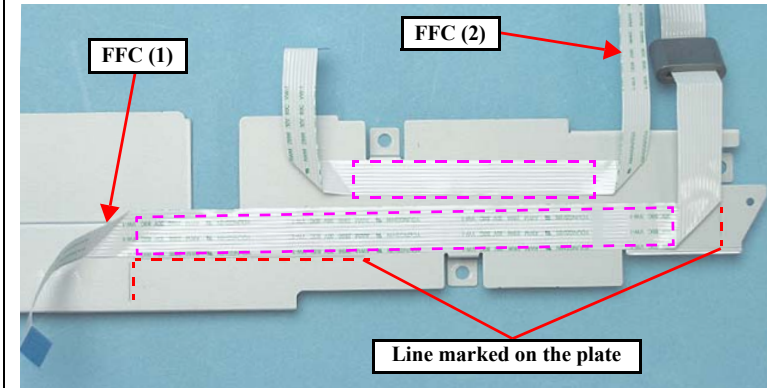

Figure 4-78. Attaching the FFC (1), FFC (2) (R360/R380/R390)

- Attach 40mm-length acetate tape referring to Fig.4-68.



When cleaning the LCD, do not use liquid type cleaner. The use of such cleaner may cause the coating film on the surface to come off. To clean the LCD, use a blower to blow off dust.

4.3.6 Middle Housing

- Parts/Components need to be removed in advance
All exterior parts/components / Card Board (USB Board) / Main Board Unit
- Removal procedure



Refer to the Orientation Definition below for the directions indicated in the following procedures.
 •“4.1.6 Orientation Definition (p.61)”

1. Remove the two screws.
 - Screw : C.B.S. M3x10 (tightening torque: 5-7 kgf.cm)
(The numbers shown in the figure indicate the order of tightening the screws.)

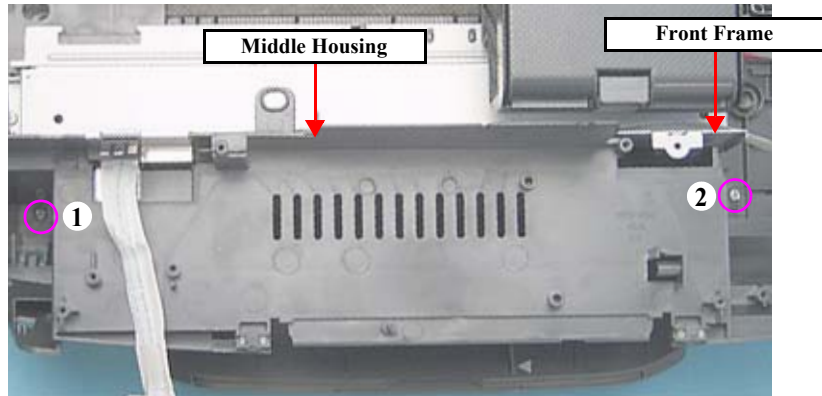

Figure 4-79. Removing the Middle Housing (1)

2. Remove the Middle Housing taking extra care not to get the FFC caught on the opening part.

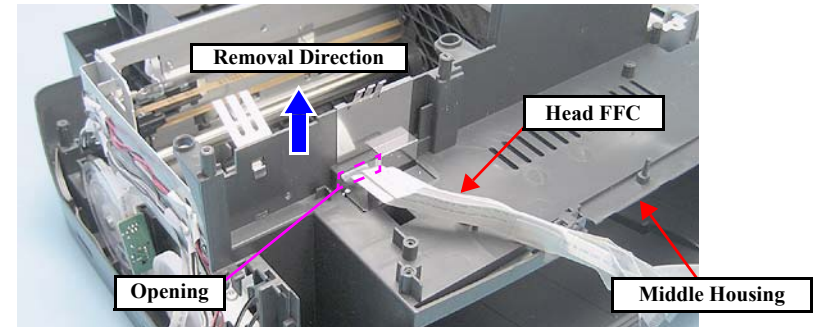

Figure 4-80. Removing the Middle Housing (2)

3. Disengage the hook from the hole of the rib, and remove the Left Ground Plate MB.
4. Remove the Right Ground Plate MB.

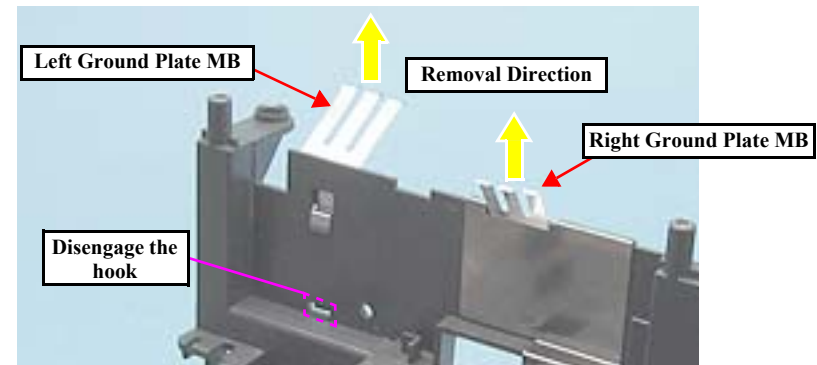

Figure 4-81. Removing the Middle Housing (3)



- Tighten the screws in the order given in Fig.4-79.
- After installing the Middle Housing, check that the Left/Right Ground Plates MB are properly grounded.

4.4 Removing the Printer Mechanism

- Parts/Components need to be removed in advance
All exterior parts/components / All control boards / Middle Housing

4.4.1 Removing the Printer Mechanism

- Removal procedure



- **Take extra care to avoid injury from sharp metal edges. Before starting, see the page given below to check the dangerous edges.**
 - “4.1.8 Sharp Metal Edges (Danger!)” (p.62)
- **Handling of the Printer Mechanism**
Whenever handling the Printer Mechanism, hold it by the positions indicated with  in the figure in order to avoid deformation of the frames.

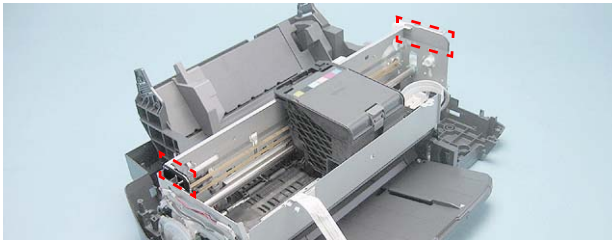

Figure 4-82. Handling the Printer Mechanism

- **Before installing/removing the Printer Mechanism, lower the CDR Guide Lever to raise the Stacker. If the Printer Mechanism is moved with the Stacker lowered, the CDR Guide Sensor that moves with the Stacker may be damaged.**

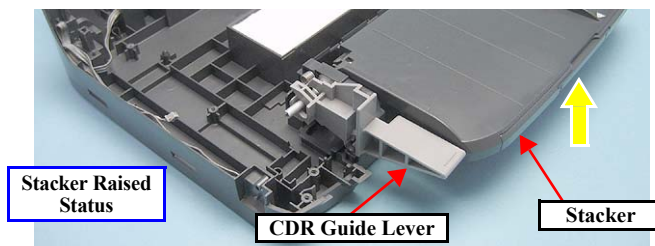

Figure 4-83. Cautions on Removing the Printer Mechanism



- Do not touch the PF Scale with bare hands or damage it.
- If the Printer Mechanism is tilted leftward about 15°, the PF Scale hits against the desk surface and can break. After removing the Printer Mechanism, take extra care to protect the PF Scale.

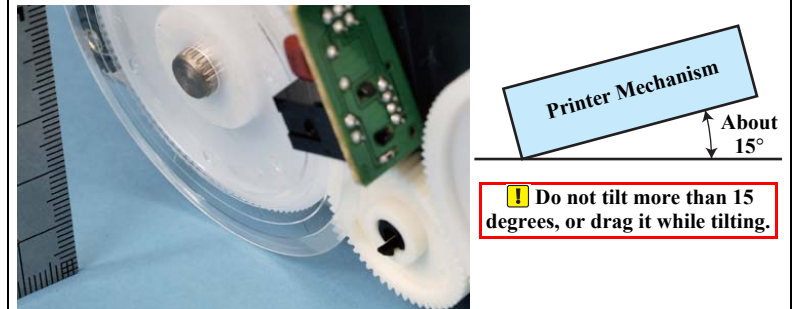

Figure 4-84. Handling of the Printer Mechanism



- Refer to the Orientation Definition below for the directions indicated in the following procedures.
- “4.1.6 Orientation Definition (p.61)”

1. Remove the acetate tape of the rear side of the Lower Housing with tweezers, and remove the Ferrite Core through the hole of the Lower Housing.

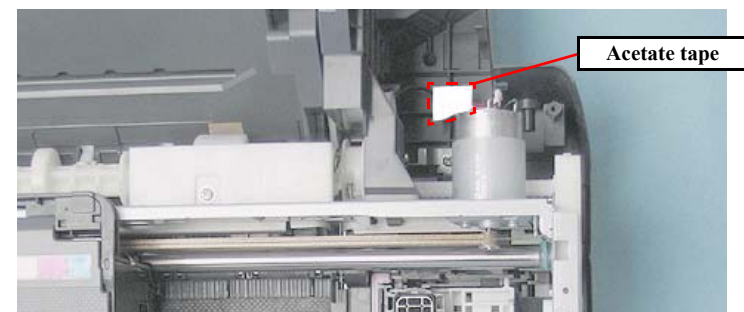



Figure 4-85. Removing the Ferrite Core (Printer mechanism)

2. Remove the six screws that secure the Printer Mechanism.
 - Screw  : C.B.P. M3x8 (tightening torque: 7-9 kgf.cm)
(The numbers shown in the figure indicate the order of tightening the screws.)

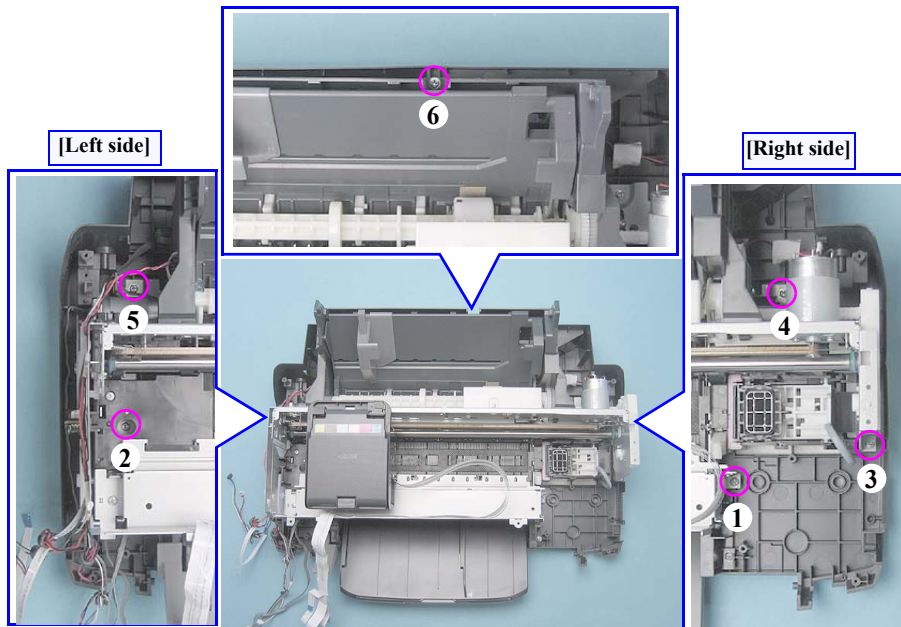

Figure 4-86. Removing the Screws (Printer Mechanism)

3. Referring to ““Figure 4-82. Handling the Printer Mechanism (p.87)””, remove the Printer Mechanism from the Lower Housing.



- When installing the Printer Mechanism, be extremely careful not to let the cables at the left front side get caught under the Printer Mechanism.
- Tighten the screws in the order given in Fig.4-86.



Before installing the Printer Mechanism, make sure that the cables are correctly routed referring to the figure below and the following pages.

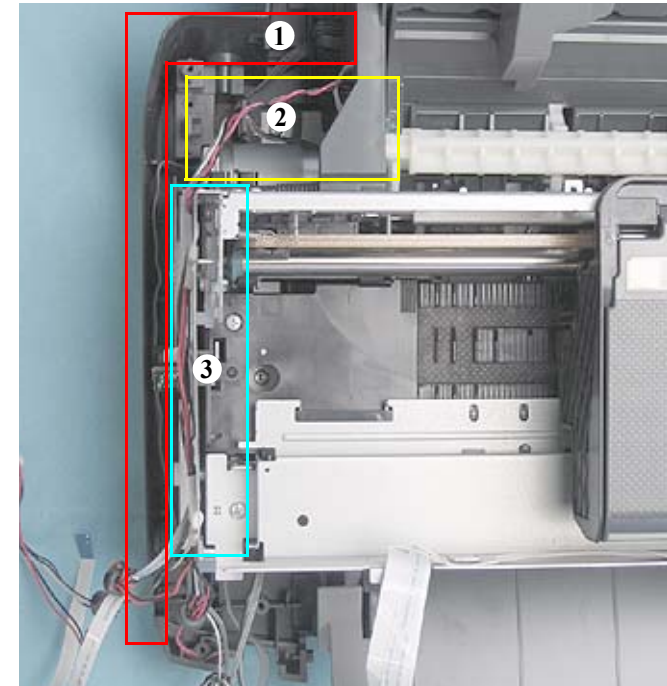

Figure 4-87. Routing the cables prior to Printer Mechanism installation

1. “Removing the Connector Cables of the P/S Assy” (p.94)
2. “Routing of the PF Motor cables” (p.103)
3. “Routing of the PF Motor cables” (p.103)
“Routing of the APG and PE Sensor Cables.” (p.102)



Whenever the Printer Mechanism is replaced, the required adjustments must be carried out.

- See “Table 5-4. Adjustment Items (p.116)” in Chapter 5

4.5 Disassembly of the Printer Mechanism

4.5.1 CR Scale

CAUTION



- **Take extra care to avoid injury from sharp metal edges. Before starting, see the page given below to check the dangerous edges.**
 - “4.1.8 Sharp Metal Edges (Danger!)” (p.62)
- **During the disassembly/reassembly of the Printer Mechanism, take extra care not to touch the CR Scale with bare hands, and not to contaminate or scratch it.**

- Parts/Components need to be removed in advance
All exterior parts/ All control boards / Middle Housing
- Removal procedure

CHECK POINT



- See the section given below on how to unlock the carriage.
 - “4.1.7 How to Unlock the Carriage (p.62)”
- Refer to the Orientation Definition below for the directions indicated in the following procedures.
 - “4.1.6 Orientation Definition (p.61)”

1. Unlock the carriage and move the CR Unit to the center.
2. Remove the Torsion Spring from the hook (○) on the left side of the Main Frame.
3. Remove the CR Scale from the hook (□) on the right side of the Main Frame.
4. Pull out the CR Scale from the slit of the CR Unit.
5. Turn the CR Scale 90 degrees in the direction of the arrow, and remove the CR Scale from the hook.

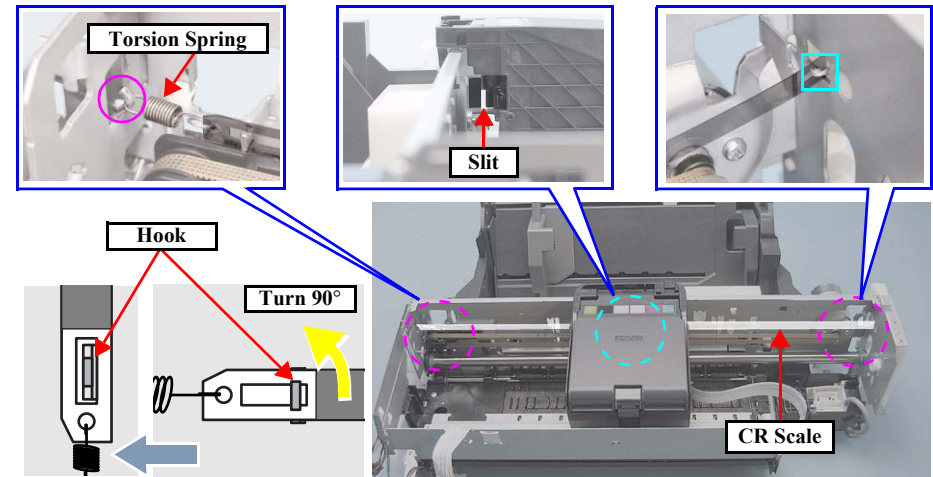

Figure 4-88. Removing the CR Scale



- **Install the CR Scale with its cut-corner facing upward. Hitch one end of the Torsion Spring to the hole of the CR Scale from the rear side of the printer.**

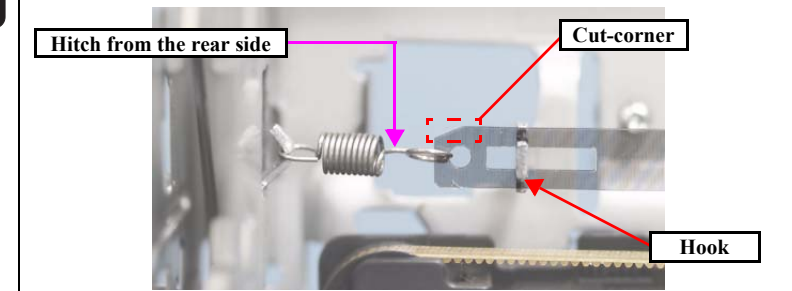

Figure 4-89. Reinstalling the CR Scale

4.5.2 APG Unit



Take extra care to avoid injury from sharp metal edges. Before starting, see the page given below to check the dangerous edges.
 •“4.1.8 Sharp Metal Edges (Danger!) (p.62)”

- Parts/Components need to be removed in advance
 All exterior parts/ All control boards / Middle Housing
- Removal procedure



Refer to the Orientation Definition below for the directions indicated in the following procedures.
 •“4.1.6 Orientation Definition (p.61)”

1. Remove two screws taking care not lose the gears, and remove the APG Unit.
 - Screw : C.B.S. M3x6 (tightening torque: 7-9 kgf.cm)
 - (The numbers shown in the figure indicate the order of tightening the screws.)

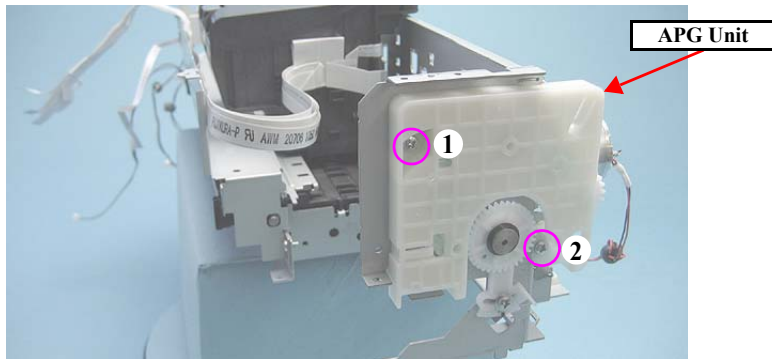

Figure 4-90. Removing the APG Unit



- Lubrication is required. See the page given below for the lubrication information.
 “6.1.3 Lubrication (p.131)”
- Install the APG Unit following the procedure below.
 1. Put a pin (thinner than Ø2mm) through the positioning holes of the Main Frame and the right PG Cam on the CR Shaft.

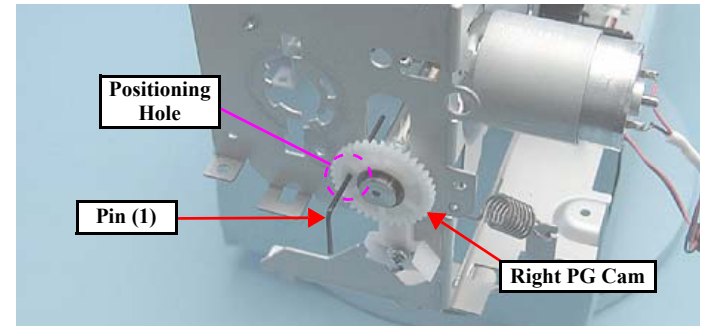

Figure 4-91. Reinstalling the APG Unit (1)

2. Put the pin through the positioning holes of the Spur gear 28.8 and the APG Unit.

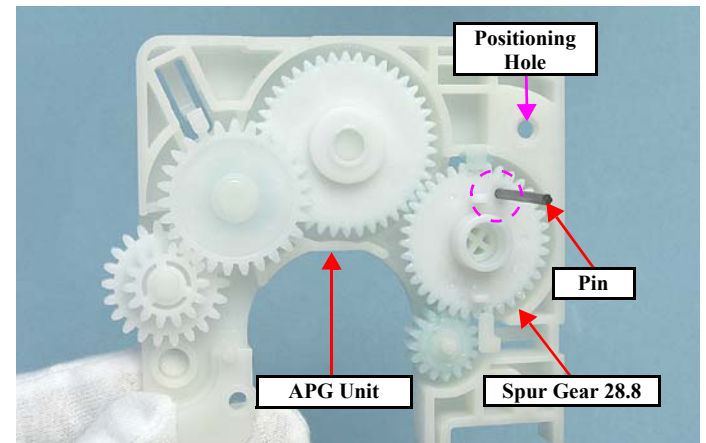

Figure 4-92. Reinstalling the APG Unit (2)

- Tighten the screws in the order given in Fig.4-90.



3. Install the APG Unit to the Main Frame.

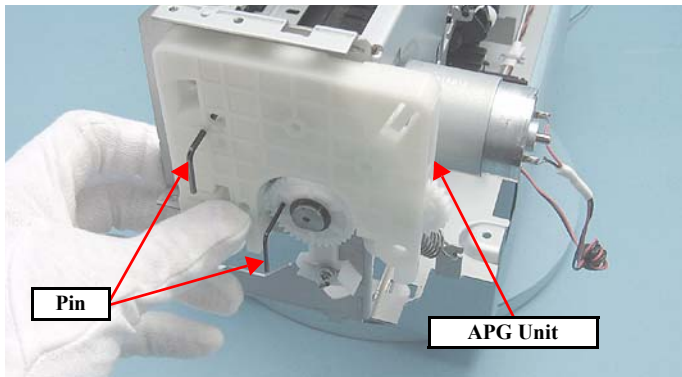

Figure 4-93. Reinstalling the APG Unit (3)

4. Check that the hooks (□) are attached to the positioning holes of the Main Frame, then screw the APG Unit.

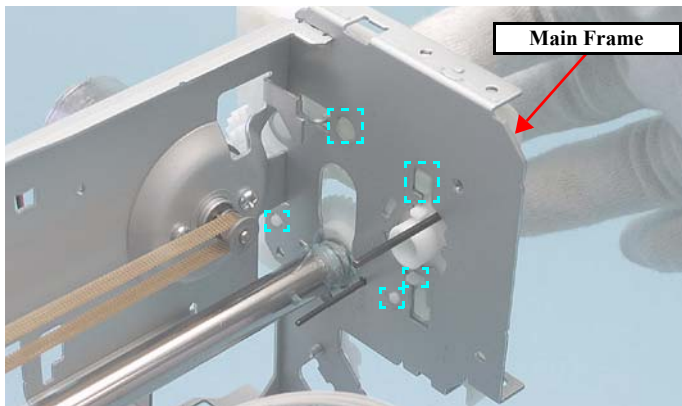

Figure 4-94. Reinstalling the APG Unit (4)

4.5.3 Printhead



- Take extra care to avoid injury from sharp metal edges. Before starting, see the page given below to check the dangerous edges.
 - “4.1.8 Sharp Metal Edges (Danger!)” (p.62)
- When removing the Head FFC Cover and the Head FFC Cover Inner, do not use tools with sharp ends as the FFC may get damaged.

- Parts/Components need to be removed in advance
 - All exterior parts/ All control boards / Middle Housing
- Removal procedure



- See the section given below on how to unlock the carriage.
 - “4.1.7 How to Unlock the Carriage (p.62)”
- Refer to the Orientation Definition below for the directions indicated in the following procedures.
 - “4.1.6 Orientation Definition (p.61)”

1. Move the CR Unit to the center, open the Cartridge Cover and remove all Ink Cartridges.
2. While disengaging the hook of the Head FFC Cover with a flathead screw driver, slide the Head FFC Cover downward and remove it.

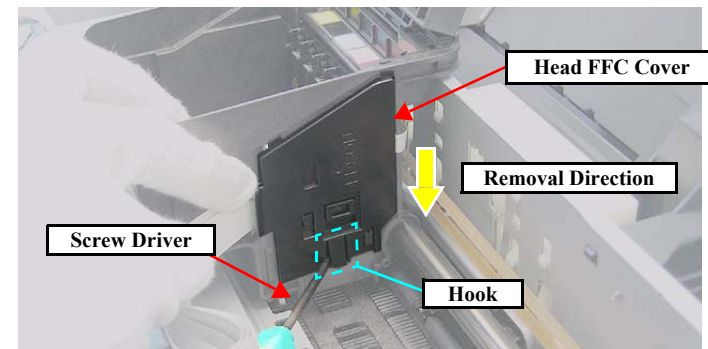

Figure 4-95. Removing the Head FFC Cover

3. Disconnect the FFC from the connector () on the Head Board.

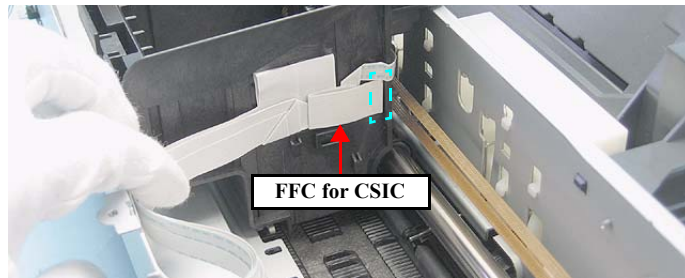

Figure 4-96. Removing the FFC for CSIC

4. While disengaging the hook of the Head FFC Cover Inner with a flathead screw driver, slide the Head FFC Cover Inner upward and remove it.

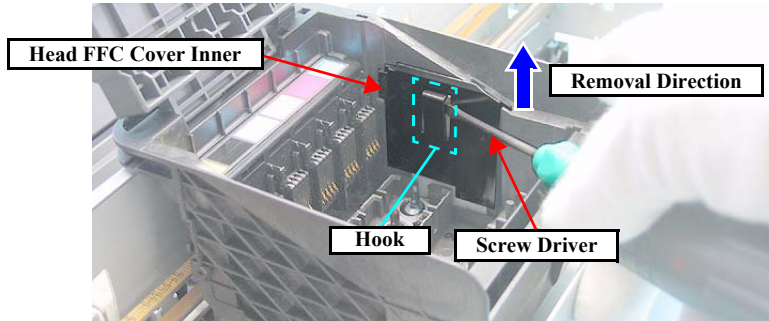

Figure 4-97. Removing the Head FFC Cover Inner

5. Move the CR Unit to its home position.
6. Insert a flathead screw driver through the hole on the right rear of the Main Frame, and disengage the hook (1) of the CSIC Assy.

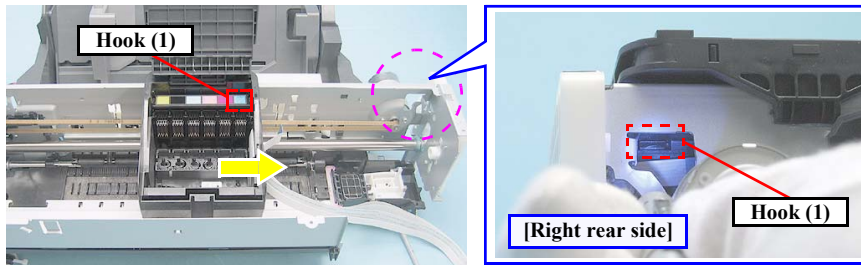

Figure 4-98. Removing the CSIC Assy (1)

7. Move the CR Unit to the left (the opposite side to the home position).
8. Taking care not to scratch the cables, insert a flathead screw driver through the hole on the left rear of the Main Frame, and disengage the hook (2) of the CSIC Assy.

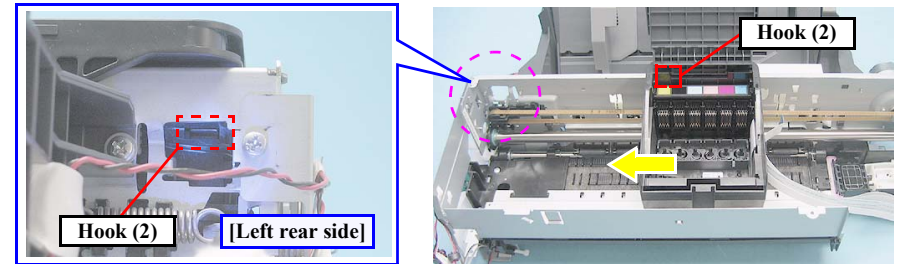

Figure 4-99. Removing the CSIC Assy (2)

9. Slide the CSIC Assy upward to remove it.

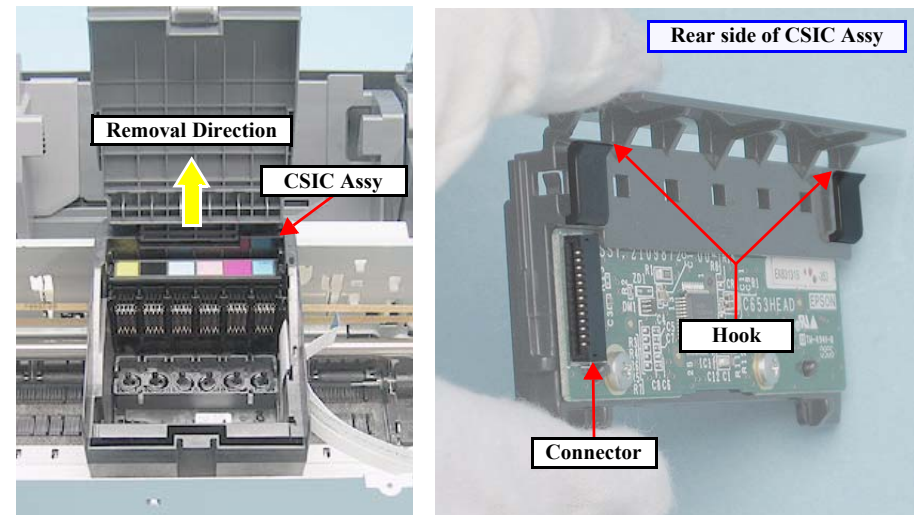

Figure 4-100. Removing the CSIC Assy (3)



Take extra care not to spill ink and contaminate the surroundings. Be extremely careful not to touch the nozzle surface, the ink supply needles and the Head Cover, otherwise the nozzles may get clogged.

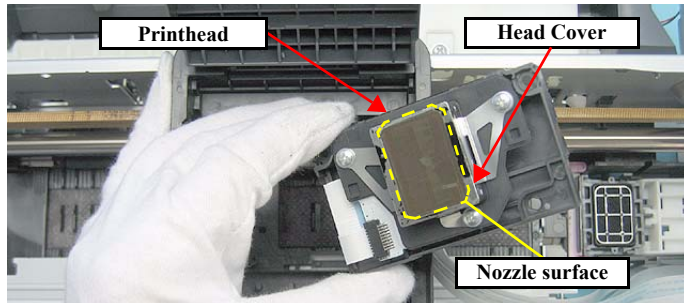



Figure 4-101. Handling of the Printhead

10. Remove three screws and remove the Printhead.

- Screw  : C.B.P. M2.6x8 (tightening torque: 3-5 kgf.cm)
(The numbers shown in the figure indicate the order of tightening the screws.)

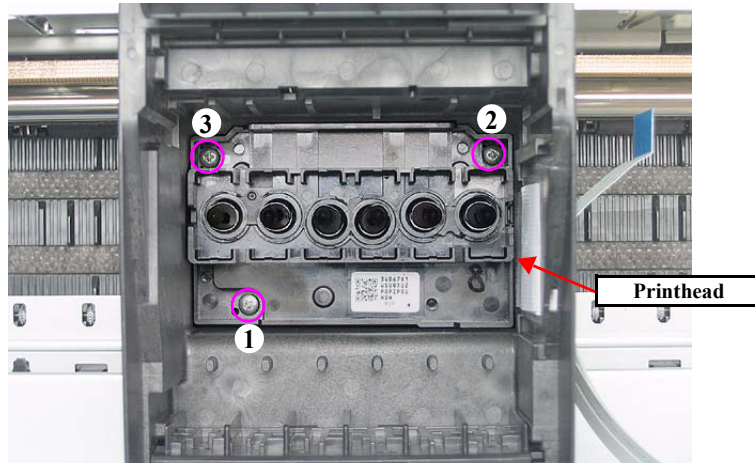

Figure 4-102. Removing the Printhead (1)

11. Remove the two Head FFCs from the connector on the back, and remove the Printhead.

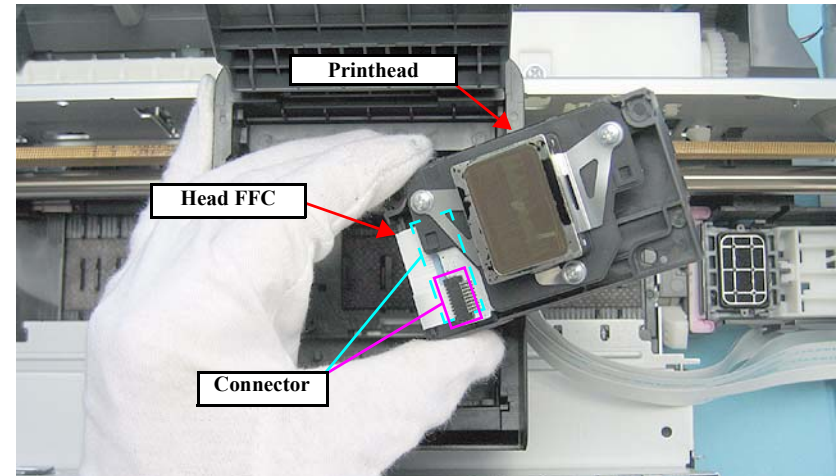

Figure 4-103. Removing the Printhead (2)



Tighten the screws in the order given in [Fig.4-102](#).



Whenever the Printhead is removed/replaced, the required adjustments must be carried out.

- See “[Table 5-4. Adjustment Items \(p.116\)](#)” in [Chapter 5](#)

4.5.4 Waste Ink Pad

- Parts/Components need to be removed in advance
All exterior parts/ All control boards / Middle Housing / Printer Mechanism
- Removal procedure

CAUTION

When removing the Waste Ink Pad, take extra care not to contaminate the printer and surroundings with ink.

1. Remove the three Waste Ink Pads from the tray.

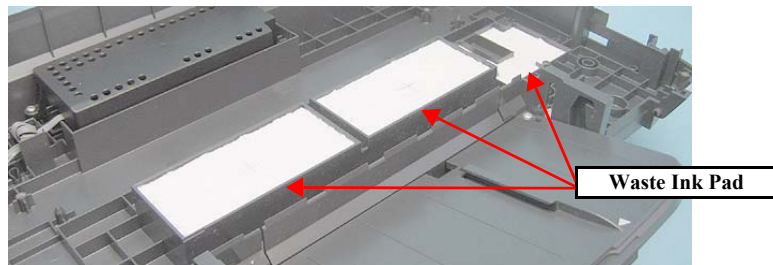

Figure 4-104. Removing the Waste Ink Pad



Insert the Waste Ink Pads into the trays inserting the slits of the pads over the tabs on the trays. Make sure to push the pads as far as they will go (until their top surface locate lower than the top surface of the tray edges).

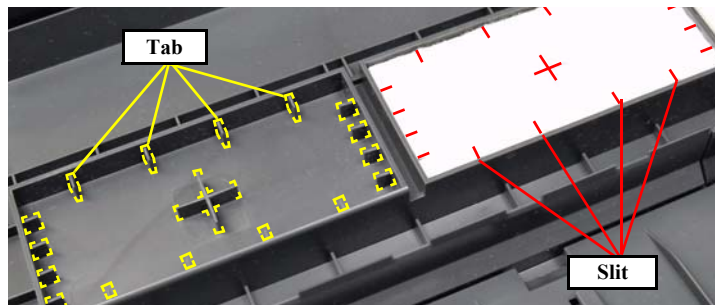

Figure 4-105. Reinstalling the Waste Ink Pads

4.5.5 P/S Assy

- Parts/Components need to be removed in advance
All exterior parts/ All control boards / Middle Housing / Printer Mechanism
- Removal procedure

CHECK POINT

Refer to the Orientation Definition below for the directions in the following procedures.
•“4.1.6 Orientation Definition (p.61)”

1. Release the connector cables from the six tabs, peel off the acetate tape and remove the Ferrite Core from the cutout of the Lower Housing.

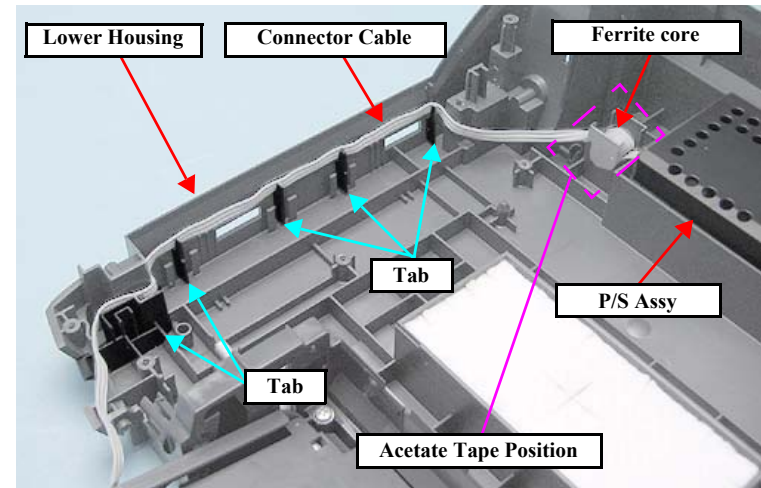



Figure 4-106. Removing the Connector Cables of the P/S Assy

2. Remove the screw that secures the P/S Assy, and remove the P/S Assy from the Lower Housing.
 - Screw  : C.B.P M3x10 (tightening torque: 5-7 kgf.cm)

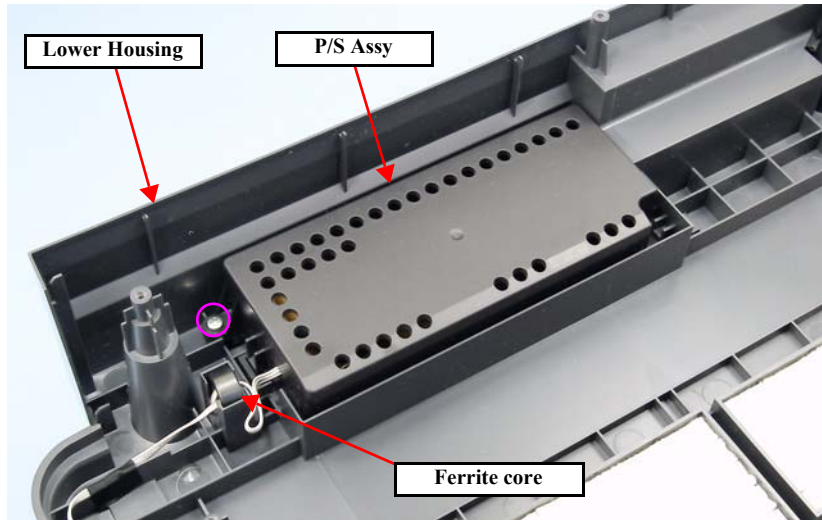

Figure 4-107. Removing the P/S Assy



When installing the P/S Assy, referring to Fig.4-106, put the Ferrite Core into the cutout of the Lower Housing, and route the connector cables through the six tabs.



Whenever the P/S Assy is replaced, the required adjustment must be carried out.
See “Table 5-4. Adjustment Items (p.116)” in Chapter 5

4.5.6 Stacker Assy

- Parts/Components need to be removed in advance
All exterior parts/ All control boards / Middle Housing / Printer Mechanism
- Removal procedure



Take extra care to avoid injury from sharp metal edges. Before starting, see the page given below to check the dangerous edges.
•“4.1.8 Sharp Metal Edges (Danger!) (p.62)”



Refer to the Orientation Definition below for the directions in the following procedures.
•“4.1.6 Orientation Definition (p.61)”

1. Lower the CDR Guide Lever to raise the Stacker.
2. Disengage the hook, and remove the CDR Guide Lever.

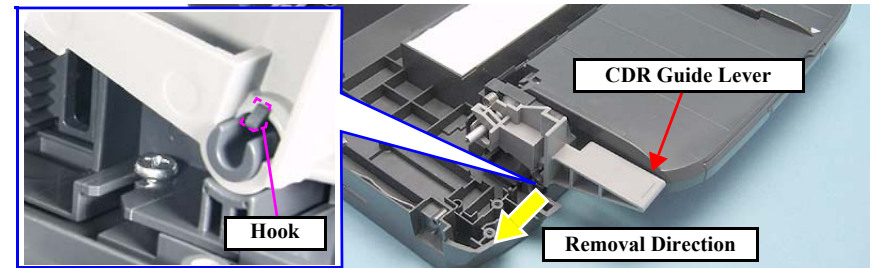

Figure 4-108. Removing the CDR Guide Lever

3. Lift the front side of the Stacker to push down its shaft side to lower the Stacker.

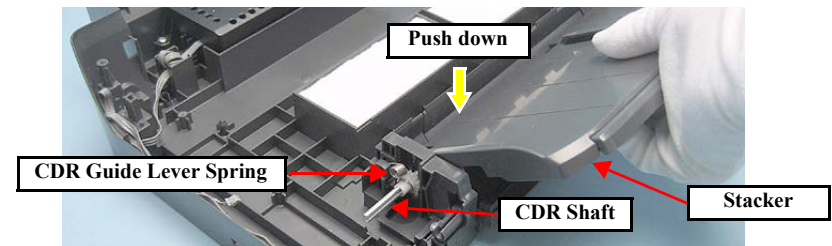

Figure 4-109. Removing the CDR Guide Lever Spring (1)

4. Follow the steps below to remove the CDR Guide Lever Spring.
 - 1) Pull the end A toward you.
 - 2) Pull the end B out of the notch.
 - 3) Pull the end A out of the shaft, and remove the CDR Guide Lever Spring.

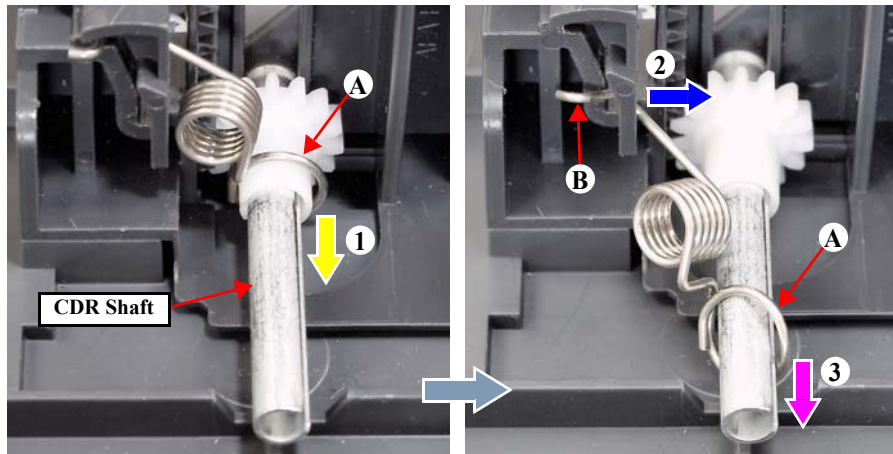



Figure 4-110. Removing the CDR Guide Lever Spring (2)

5. Remove the four screws that secure the Stacker Assy.
 - Screw  : C.B.P. M3x8 (tightening torque: 5-7 kgf.cm)
(The numbers shown in the figure indicate the order of tightening the screws.)
6. Holding the Left/Right Stacker Guides, remove the Stacker Assy from the Lower Housing.

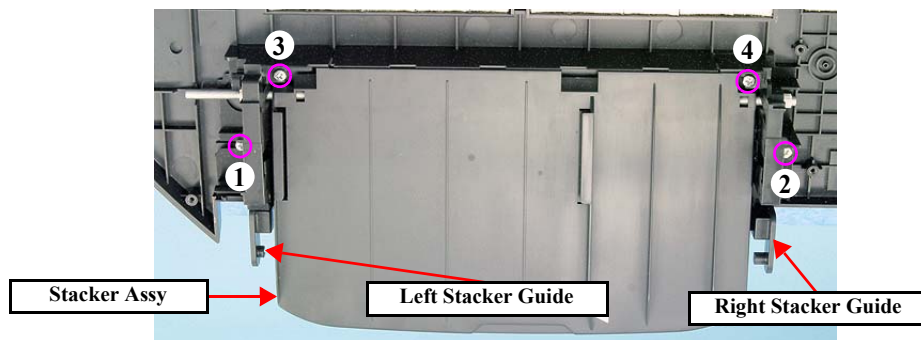

Figure 4-111. Removing the Stacker Assy

7. While disengaging the hook, remove the left gear from the CDR Shaft and remove the Left Stacker Guide. Also remove the Right Stacker Guide in the same way.
8. Remove the CDR Shaft from the Stacker.

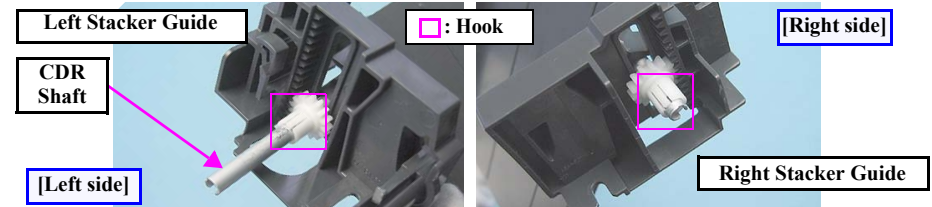

Figure 4-112. Removing the CDR Shaft



- Lubrication is required. See the page given below for the lubrication information. **"6.1.3 Lubrication (p.131)"**
- Install the CDR Shaft so that one of its gear holes further to the shaft end goes to the left (the spring attached side).
- When attaching the CDR Shaft, make sure to match the phases of the left and right gears as shown below.
 - Insert the gear tooth with a small protrusion on its root into the groove between the 3rd and 4th teeth of the Stacker Guide Left/Right.

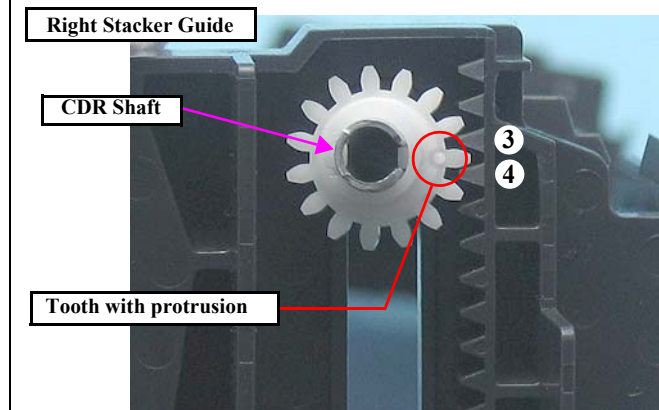

Figure 4-113. Reinstalling the CDR Shaft



When installing the Stacker Assy, insert the tabs  of the Left/Right Stacker Guides into the hole of the Lower Housing, and secure the guides with the screws. Tighten the screws in the order given in Fig.4-111.



Figure 4-114. Reinstalling the Stacker Assy

4.5.7 Ink System



- **Take extra care to avoid injury from sharp metal edges. Before starting, see the page given below to check the dangerous edges.**
 - “4.1.8 Sharp Metal Edges (Danger!)” (p.62)
- Take extra care not to spill ink and contaminate the surroundings. Also, when removing the Waste Ink Tube, be careful not to spill the ink.
- Extra care must be taken to avoid injury from sharp edges of the rib of the Main Frame.
- Be careful not to drop and damage the shaft of the Carriage Lock and the Torsion Spring, as they easily come off.

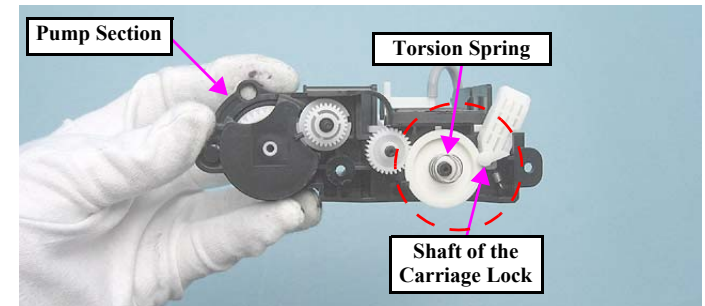



Figure 4-115. Ink System

- Parts/Components need to be removed in advance
All exterior parts/ All control boards / Middle Housing / Printer Mechanism
- Removal procedure



- See the section given below on how to unlock the carriage.
 - “4.1.7 How to Unlock the Carriage (p.62)”
- Refer to the Orientation Definition below for the directions indicated in the following procedures.
 - “4.1.6 Orientation Definition (p.61)”

1. Move the CR Unit to the center.
2. Remove the screw (1) that secures the Cap section.
 - Screw : C.B.S. M3x6 (tightening torque: 7-9 kgf.cm)
(The numbers shown in the figure indicate the order of tightening the screws.)
3. Insert a screwdriver through the hole of the Main Frame and remove the screw (2) that secure the Pump section.
 - Screw : C.B.S. M3x6 (tightening torque: 7-9 kgf.cm)
(The numbers shown in the figure indicate the order of tightening the screws.)

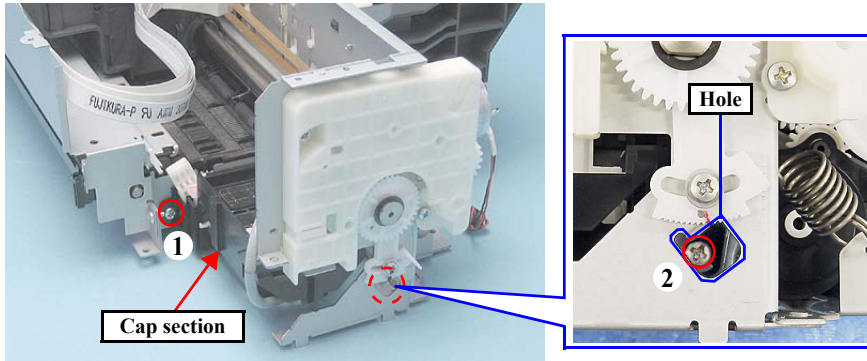

Figure 4-116. Removing the Ink System (1)

4. Slide the Cap section in the direction of the arrow and remove the Ink System.

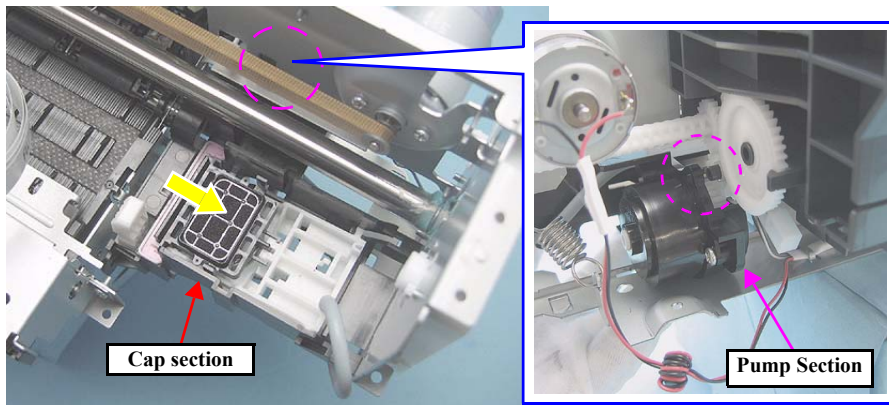

Figure 4-117. Removing the Ink System (2)

5. Pull out the Ink System towards the front to remove it avoiding contact of the Pump and the rib of the opening.

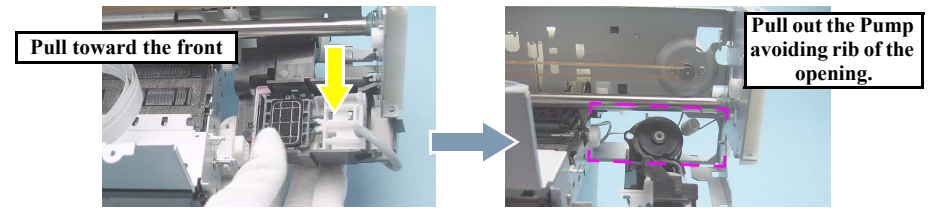



Figure 4-118. Removing the Ink System (2)



- Lubrication is required. See the page given below for the lubrication information.
"6.1.3 Lubrication (p.131)"
- Insert the shafts of the Ink System into the positioning holes () of the Frame.

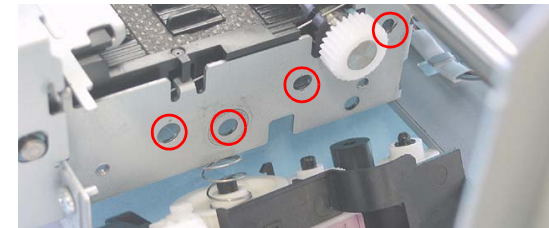

Figure 4-119. Reinstalling the Ink System (1)

- Insert the positioning hole of the Ink System over the guide pin of the ASF Unit.

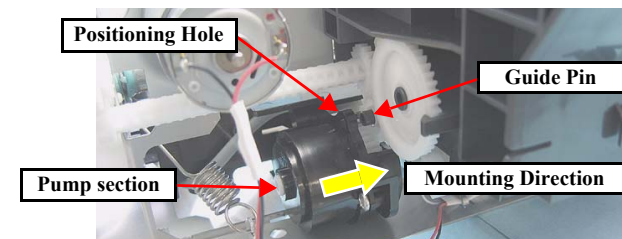

Figure 4-120. Reinstalling the Ink System (2)

- Tighten the screws in the order given in Fig.4-116.
- After installing the Ink System, check the Carriage Lock for proper operation referring to "4.1.7 How to Unlock the Carriage (p.62)".

4.5.8 CR Motor



Take extra care to avoid injury from sharp metal edges. Before starting, see the page given below to check the dangerous edges.
 •“4.1.8 Sharp Metal Edges (Danger!)” (p.62)

- Parts/Components need to be removed in advance
 All exterior parts/ All control boards / Middle Housing / Printer Mechanism / CR Scale
- Removal procedure



Refer to the Orientation Definition below for the directions indicated in the following procedures.
 •“4.1.6 Orientation Definition (p.61)”

1. Remove the Extension Spring of the Driven Pulley Assy from the rear side.

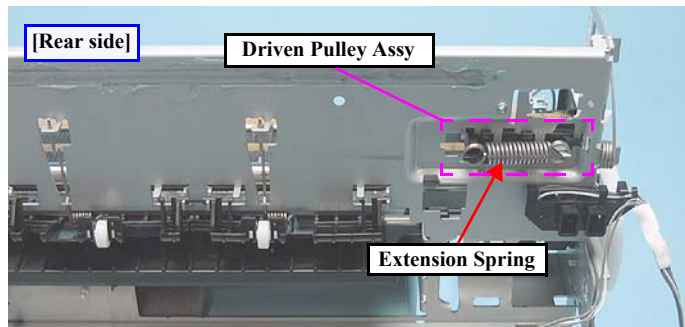

Figure 4-121. Removing the Extension Spring



Take extra care not to contaminate the Timing Belt with grease. The belt deteriorates faster if grease adheres to it.

2. Remove the Driven Pulley Assy and remove the Timing Belt from the Pinion Gear of the CR Motor.

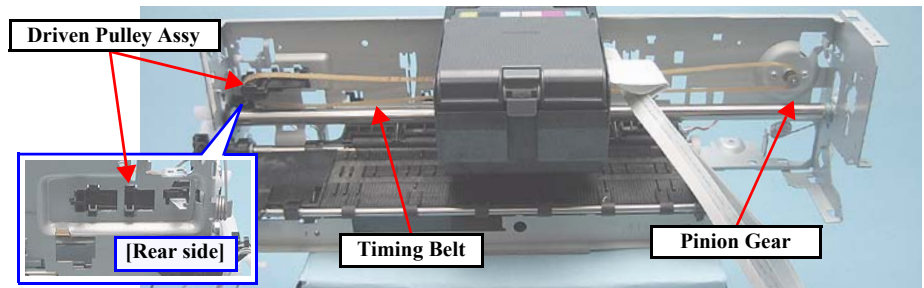

Figure 4-122. Removing the CR Motor (1)

3. Disengage the connector cables from the three hooks and peel off the three acetate tapes.

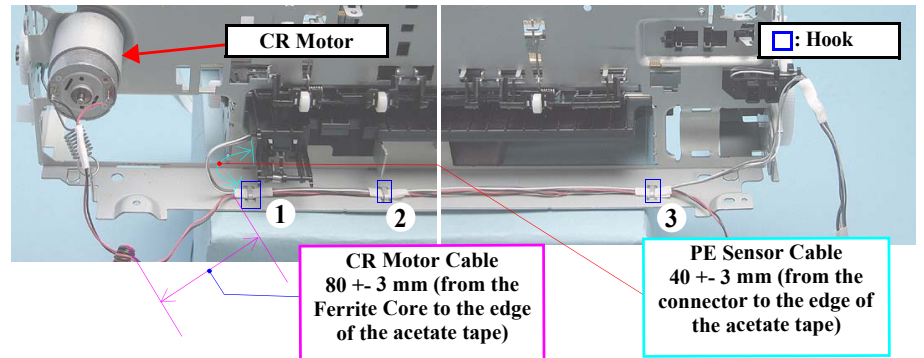

Figure 4-123. Removing the CR Motor (2)

4. Remove the two screws and remove the CR Motor.
 • Screw ○: C.P. M3x4 (tightening torque: 3-5 kgf.cm)
 (The numbers shown in the figure indicate the order of tightening the screws.)

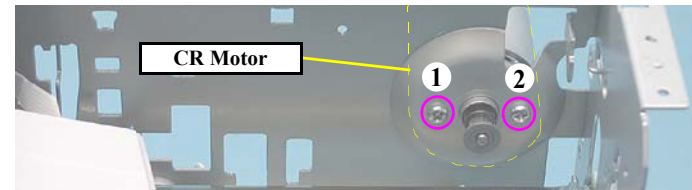

Figure 4-124. Removing the CR Motor (3)



- Lubrication is required. See the page given below for the lubrication information.
"6.1.3 Lubrication (p.131)"
- When installing the CR Motor, install it so that the print side faces upwards.



Figure 4-125. Reinstalling the CR Motor

- Tighten the screws in the order given in Fig.4-124.
- When installing the Timing Belt, make sure that it is not twisted and the lumpy side faces inward.
- Routing of the CR Motor/PE Sensor cables
 - Route the cables as described below referring to the Fig.4-123.
 - 1. Wrap the CR Motor Cable together with the PE Sensor Cable with the 20mm-length acetate tape at the (1) position.
 - 2. Align the center of the taped portion with the center of the hook (1), then wrap the cables at another two positions each with 20 mm-length acetate tape so that the center of the each taped portion comes to the center of hook (2) and (3) respectively.
 - 3. Secure the taped cables with the (1) (2) (3) hooks so that the PE Sensor Cable faces inward.
- Route the PE Sensor Cable on the left side of the printer referring to the page below.
"Routing of the APG and PE Sensor Cables." (p.102)
- Route the PF Motor cables on the left side of the printer referring to the page below.
"Routing of the PF Motor cables" (p.103)



Whenever the CR Motor is replaced, the required adjustments must be carried out.
See "Table 5-4. Adjustment Items (p.116)" in Chapter 5

4.5.9 EJ Frame Assy



Take extra care to avoid injury from sharp metal edges. Before starting, see the page given below to check the dangerous edges.
•"4.1.8 Sharp Metal Edges (Danger!)" (p.62)

- Parts/Components need to be removed in advance
All exterior parts/ All control boards / Middle Housing / Printer Mechanism / CR Scale / APG Unit
- Removal procedure



Refer to the Orientation Definition below for the directions indicated in the following procedures.
•"4.1.6 Orientation Definition (p.61)"

1. Move the CR Unit to the HP side.

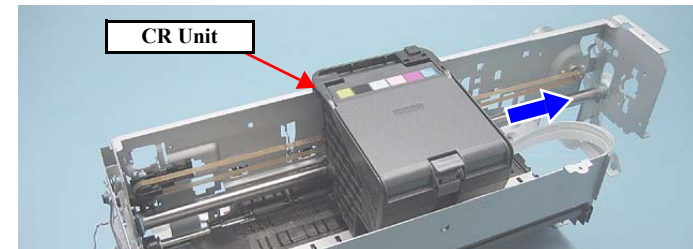

Figure 4-126. Moving the CR Unit

2. Peel off the acetate tape, and disengage the Head FFC from the hook, peel off the two double-sided tapes and remove the Head FFC from the Front Frame.

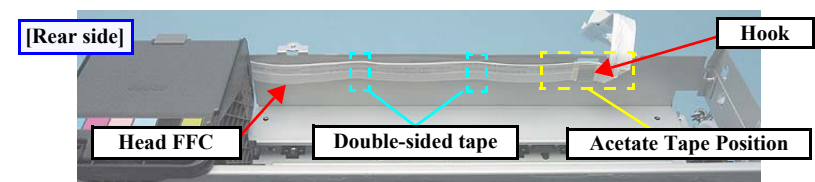



Figure 4-127. Removing the Head FFC

3. Disengage the connector cables of the PE Sensor and the APG Sensor from the two hooks (A).
4. Remove the two screws and remove the Cable Holder Frame from the two hooks (B).

 - Screw  : C.B.S. M3x6 (tightening torque: 7-9 kgf.cm)
(The numbers shown in the figure indicate the order of tightening the screws.)

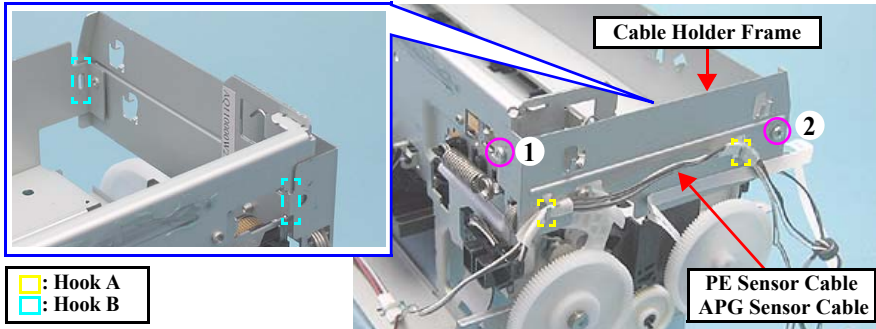

Figure 4-128. Removing the Cable Holder Frame

5. Remove the left and right screws, and remove the Front Frame.

 - Screw  : C.B.S. M3x6 (tightening torque: 7-9 kgf.cm)
(The numbers shown in the figure indicate the order of tightening the screws.)



Figure 4-129. Removing the Front Frame

6. Remove the EJ Frame Assy.

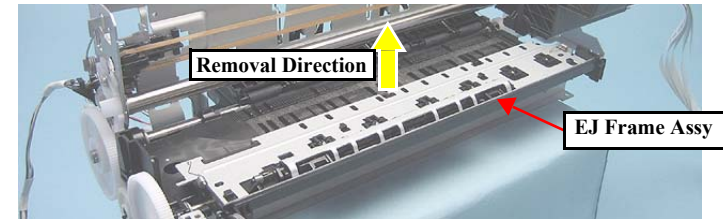

Figure 4-130. Removing the EJ Frame Assy



- Lubrication is required. See the page given below for the lubrication information.
"6.1.3 Lubrication (p.131)"
- When installing the EJ Frame Assy, insert its two lower bushings over the EJ Roller Shaft.

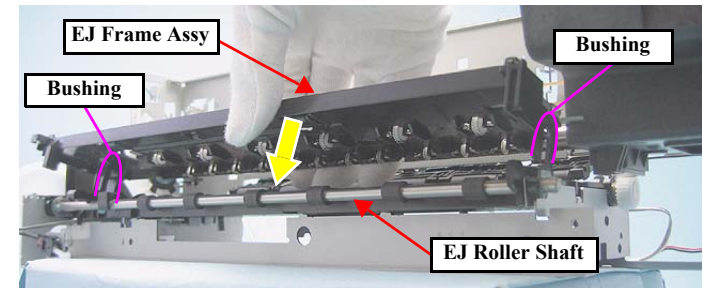

Figure 4-131. Reinstalling the EJ Frame Assy

- When installing the EJ Frame, make sure that the Left/Right EJ Frame Springs are attached as shown in the figure below. Carefully handle the EJ Frame as the springs come off easily.

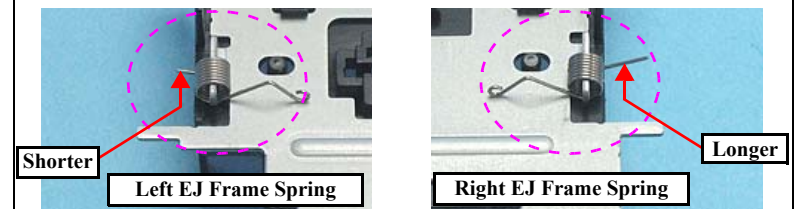

Figure 4-132. Reinstalling the Front Frame (1)



- When installing the Front Frame, screw it after securing the foot of the two EJ Frame Springs to the slits as shown in the figure. Carefully handle the EJ Frame as the springs come off easily.

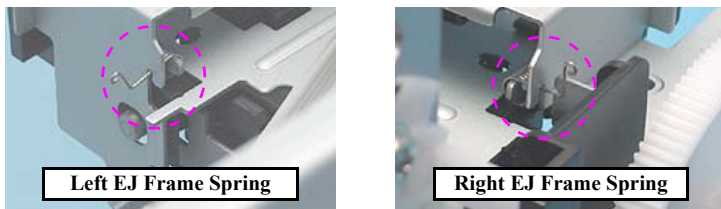

Figure 4-133. Reinstalling the Front Frame (2)

- Screw the Cable Holder Frame in the order given in Fig.4-128.
- Screw the Front Frame in the order given in Fig.4-129.
- Routing of the APG and PE Sensor Cables.

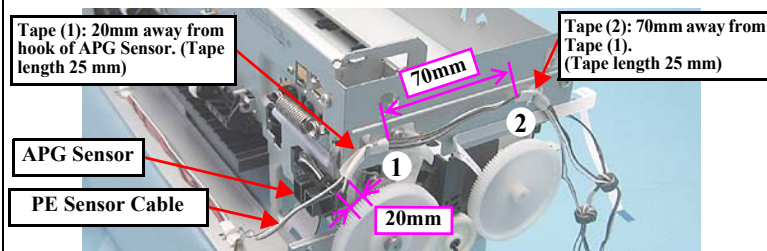

Figure 4-134. Acetate Tape Position

- Route the CR Motor/PE Sensor cables on the rear of the printer referring to the page below. [Figure 4-123 "Removing the CR Motor \(2\)" \(p.99\)](#)
- Route the PF Motor/PF Encoder and CR Motor cables on the left side of the printer referring to the page below. ["Routing of the PF Motor cables" \(p.103\)](#)

4.5.10 PF Encoder / PF Scale / PF Motor



- **Take extra care to avoid injury from sharp metal edges. Before starting, see the page given below to check the dangerous edges.**
 - ["4.1.8 Sharp Metal Edges \(Danger!\)" \(p.62\)](#)
- Take extra care not to contaminate or scratch the PF Scale. Never touch the scale with bare hands.

- Parts/Components need to be removed in advance
All exterior parts/ All control boards / Middle Housing / Printer Mechanism
- Removal procedure



Refer to the Orientation Definition below for the directions indicated in the following procedures.

- ["4.1.6 Orientation Definition \(p.61\)"](#)

- Removing the PF Encoder/PF Scale
 1. Disconnect the FFC of the PF Encoder from CN1 connector.
 2. Remove the screw and remove the PF Encoder.
 - Screw ○ : C.B.P. M2.6x8 (tightening torque: 3.5-4.5 kgf.cm)
 3. Peel off the double-sided tape attached to the center part, and remove the PF Scale.

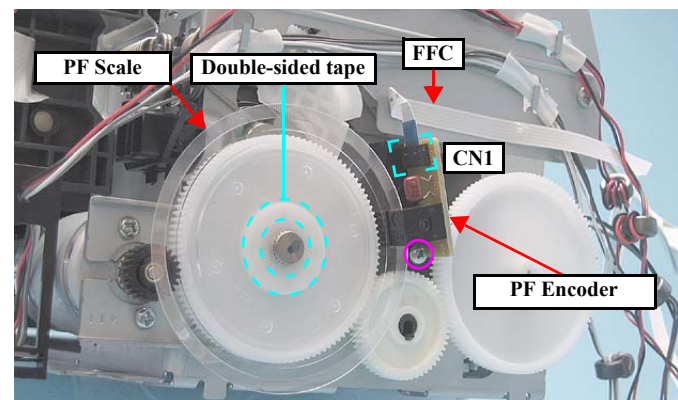

Figure 4-135. Removing the PF Encoder/PF Scale

- Removing the PF Motor
- 4. Peel off the acetate tape (1), and remove the Ferrite Core from the cutout of the ASF Unit.
- 5. Disengage the PF Motor connector cable from the hook (1) of the ASF Unit.
- 6. Disengage the cables of the PF Motor and the CR Motor that are secured with two pieces of acetate tape from the two hooks (2), peel off the acetate tape and remove the PF Motor cable.
- 7. Remove the Harness Holder, and disengage the cables of the CR Motor and the PE Sensor from hook (3).

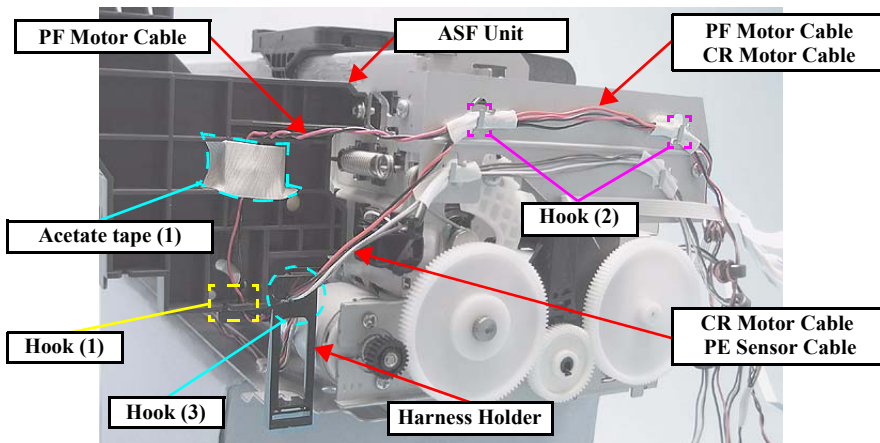



Figure 4-136. Removing the Harness Holder

- 8. Remove the two screws that secure the PF Motor, and slide the motor to pull it out through the cutout to remove it.
 - Screw  : C.P. M3x6 (tightening torque: 7-9 kgf.cm)
(The numbers shown in the figure indicate the order of tightening the screws.)

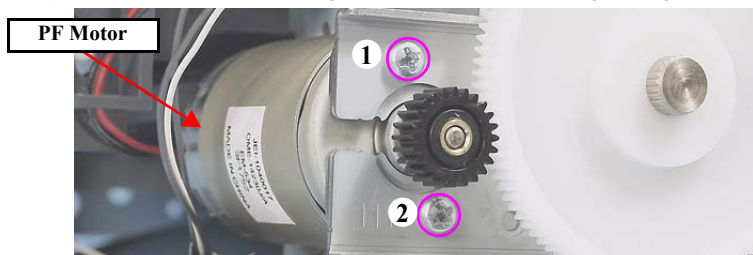

Figure 4-137. Removing the PF Motor



- Install the PF motor so that its label faces toward you.
- Tighten the screws in the order given in Fig.4-137.
- When installing the PF Encoder, check that its reading part does not contact with the PF Scale.
- Routing of the PF Motor cables
The cables of the PF Motor and the CR Motor must be secured with acetate tapes and routed as shown below. Make sure to secure the taped portion of the cables with hooks.

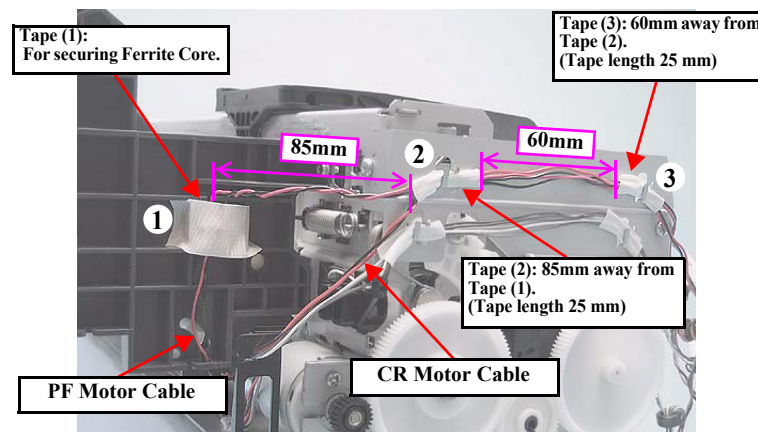

Figure 4-138. Routing/Securing the PF Motor/CR Motor Cables

- Route the APG and PE Sensor cables on the left side of the printer referring to the page below.
[“Routing of the APG and PE Sensor Cables.” \(p.102\)](#)
- Route the CR Motor and PE Sensor cables on the rear of the printer referring to the page below.
[Figure 4-123 “Removing the CR Motor \(2\)” \(p.99\)](#)



Whenever the PF Motor is replaced, the required adjustments must be carried out.

See [“Table 5-4. Adjustment Items \(p.116\)”](#) in Chapter 5

4.5.11 ASF Unit

- Parts/Components need to be removed in advance
All exterior parts/ All control boards / Middle Housing / Printer Mechanism / Ink System
- Removal procedure

CHECK POINT

Refer to the Orientation Definition below for the directions indicated in the following procedures.

- **“4.1.6 Orientation Definition (p.61)”**

- Removing the LD Roller Guide
 1. Move the CR Unit to the left (the opposite side to the home position).
 2. Remove the screw that secures the LD Roller Guide.
 - Screw : C.B.S. (P4), M3x6 (tightening torque: 7-9 kgf.cm)
 3. Push the tabs on the right and the left, slide the LD Roller Guide upward to remove it disengaging the five hooks.

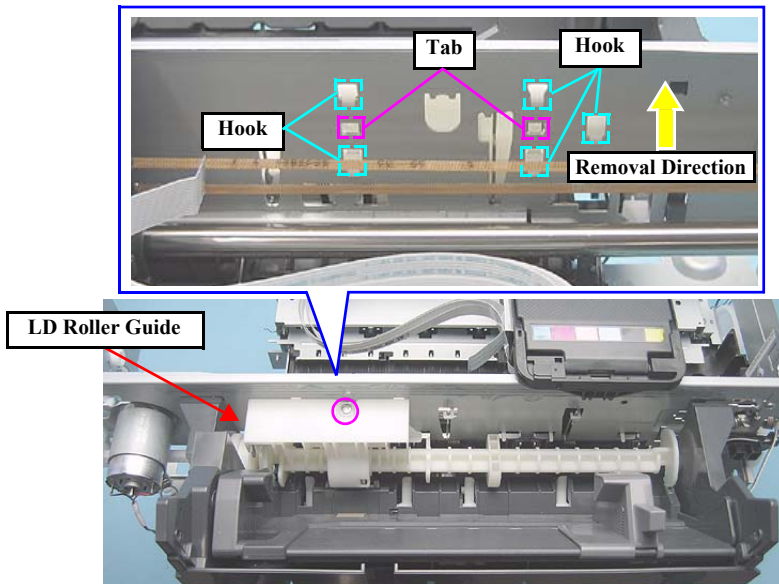

Figure 4-139. Removing the LD Roller Guide (1)

4. Remove the Torsion Spring 137.7 from the LD Roller Guide.

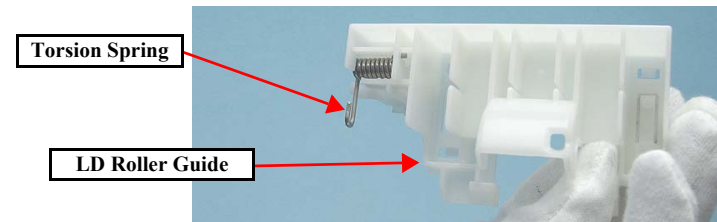

Figure 4-140. Removing the LD Roller Guide (2)

- Removing the ASF Assy
 5. Remove the two screws on the rear side.
 - Screw : C.B.S.(P4), M3x6 (tightening torque: 7-9 kgf.cm)
(The numbers shown in the figure indicate the order of tightening the screws.)

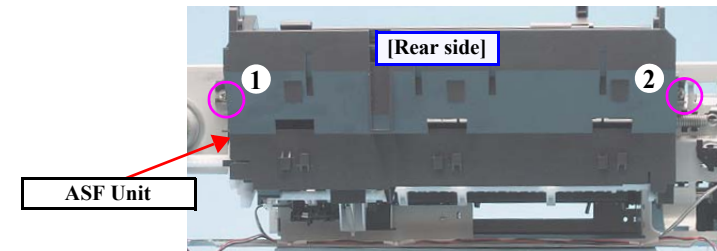

Figure 4-141. Removing the Screws (ASF Unit)

6. Remove the hooks (1), (2) and the tip of the Change Lever that secure the ASF Unit from the Main Frame.

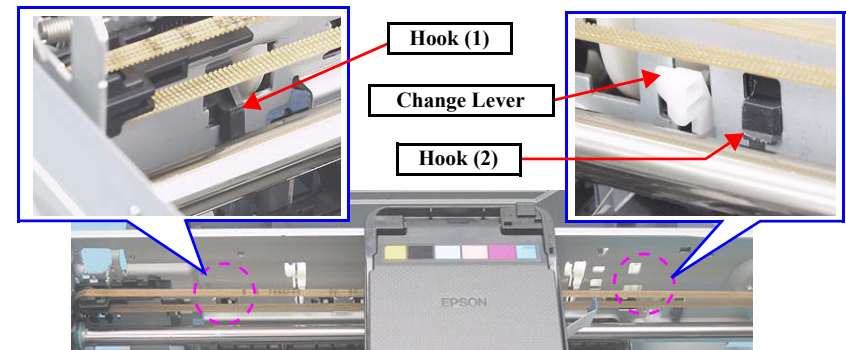

Figure 4-142. Disengaging the Hooks (ASF Unit)

7. Remove the Combination Gear (10, 15.2), and remove the ASF Unit.

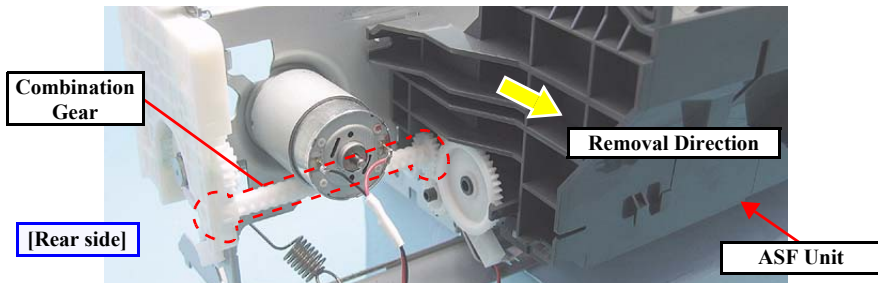

Figure 4-143. Removing the ASF Unit



- Lubrication is required. See the page given below for the lubrication information. ["6.1.3 Lubrication \(p.131\)"](#)
- When installing the ASF Unit, make sure that the Combination Gear, tip of the Change Lever and the two hooks are securely attached. Also make sure that there is appropriate space at both the left and right of the Change Lever.
- Tighten the screws in the order given in [Fig.4-141](#).
- Install the LD Roller following the procedure below. Make sure to apply grease referring to the page given below. ["6.1.3 Lubrication \(p.131\)"](#)
Install the LD Roller aligning the arrow on the LD Roller with the arrow on the blade of the shaft. Make sure the LD Roller is securely attached without gap or misalignment.

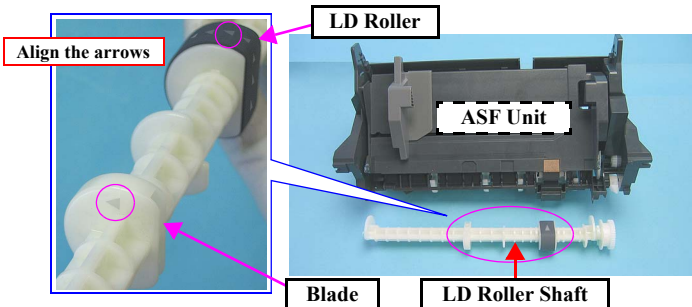

Figure 4-144. Reinstalling the LD Roller

4.5.12 CR Unit

- Parts/Components need to be removed in advance
All exterior parts/ All control boards / Middle Housing / Printer Mechanism / CR Scale / APG Unit / CR Motor / EJ Frame Assy
- Removal procedure



Refer to the Orientation Definition below for the directions indicated in the following procedures.
•["4.1.6 Orientation Definition \(p.61\)"](#)



Before turning the Parallelism Bushing L, mark the scale position of the Parallelism Bushing with a marker. And taking extra care not to damage the Gear with the rib, pull it toward the front.

1. Disengage the upper end of the Spring (1) from the slit, and remove the Spring (1).
2. Loosen the screw (○), and turn the Parallelism Bushing L clockwise to the maximum.

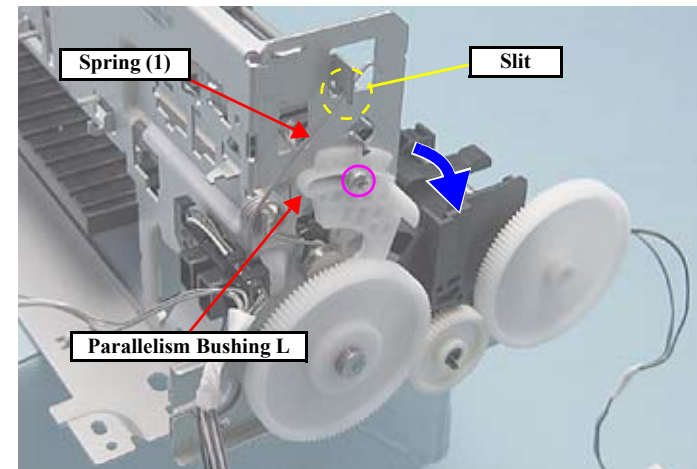

Figure 4-145. Removing the CR Unit (1)

3. Disengage the end of the Spring (2) from the hook, and the other end from the slit of the CR shaft, and remove the Spring (2).
4. Remove the washer, and remove the Right PG Cam.

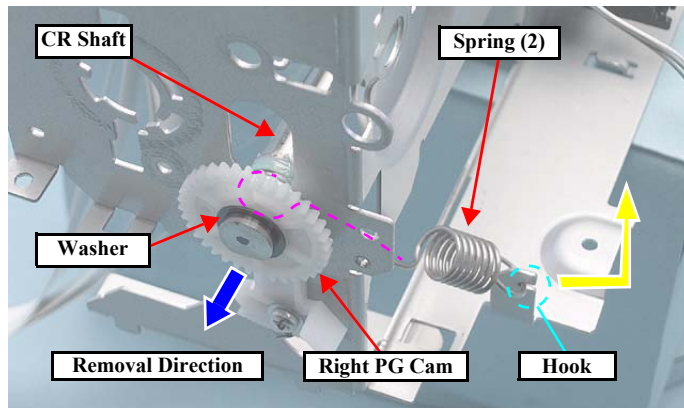

Figure 4-146. Removing the CR Unit (2)

5. Hold the CR Unit from the bottom and lift up the CR Shaft, release from the bushing in the (1) (2) order, and remove the CR Unit with the Shaft from the Main Frame.

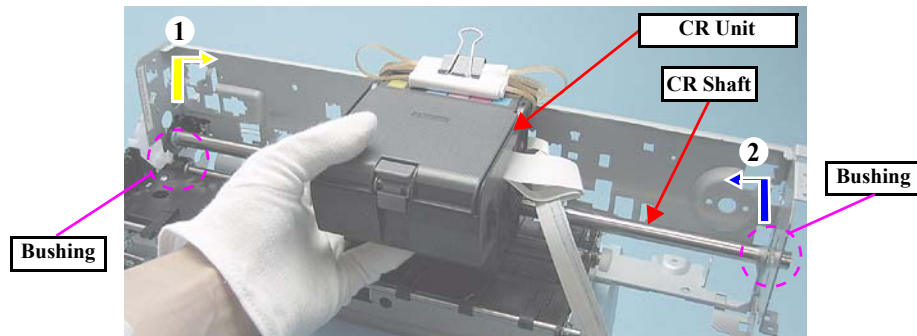

Figure 4-147. Removing the CR Unit (3)

6. Remove the CR Shaft from the CR Unit.

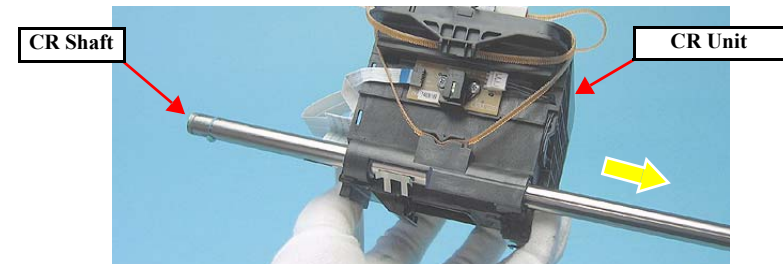

Figure 4-148. Removing the CR Unit (4)

7. Remove the Timing Belt from the CR Unit.

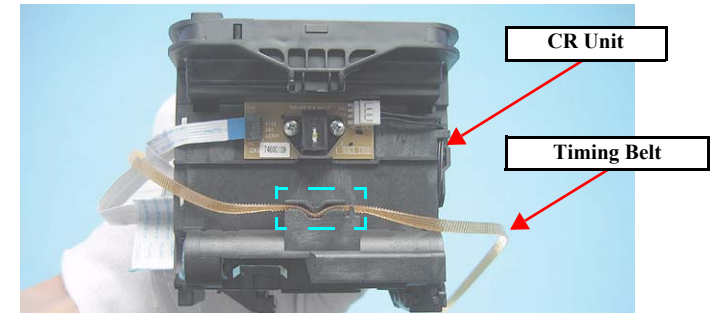

Figure 4-149. Removing the CR Unit (5)

8. Disconnect the FFC from the CR Encoder connector, pull out the FFC from the slit of the CR Unit, and remove the Head FFC.

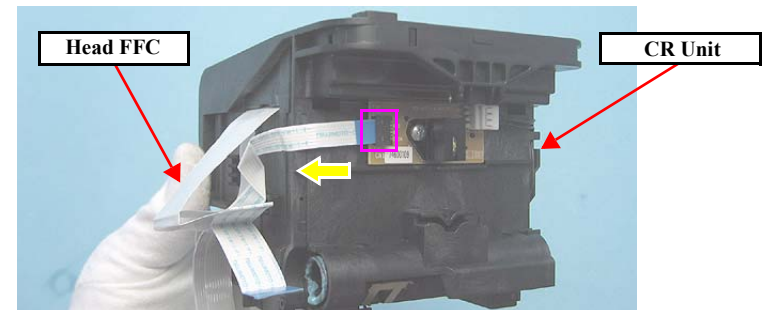

Figure 4-150. Removing the CR Unit (6)



- Lubrication is required. See the page given below for the lubrication information.
"6.1.3 Lubrication (p.131)"
- Before attaching the right PG cam, remove the APG Unit and install the cam matching its phase with the APG Unit. (See Fig.4-91, Fig. 4-92)
- When attaching the spring (2) and the washer for the Right PG Cam to the CR Shaft, make sure to attach them to the positioning slits on the CR Shaft. (See Fig.4-146)
- When installing the Timing Belt, make sure that it is not twisted and the lumpy side comes to the inner side.

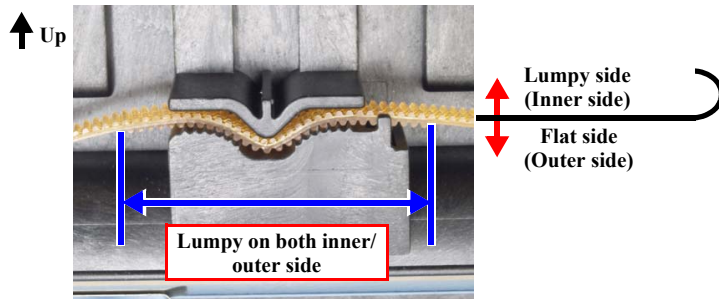

Figure 4-151. Reinstalling the Timing Belt

- When installing the CR Unit, hook the Guide part to the Main Frame.

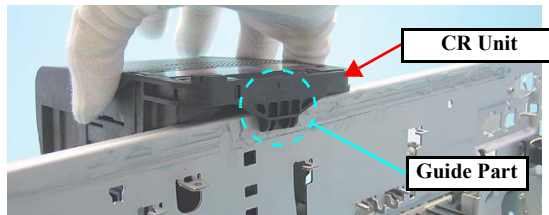

Figure 4-152. Reinstalling the CR Unit



- Whenever the CR Unit is removed or replaced, the required adjustments must be carried out.
- See "Table 5-4. Adjustment Items (p.116)" in Chapter 5



Remove the Cartridge Cover following the steps below. The Hinge, Cover Cartridge need to be cut with a nipper or similar tool to be removed. Therefore, whenever replacing the Cartridge Cover, the Hinge, Cover Cartridge also must be replaced with a new one.

1. Cut the convex portion of the Hinge, Cover Cartridge with a nipper or similar tool.
2. Disengage the hook from the opening made by the cut and remove the Hinge, Cover Cartridge.
3. Remove the Cartridge Cover pulling out its two guide pins.

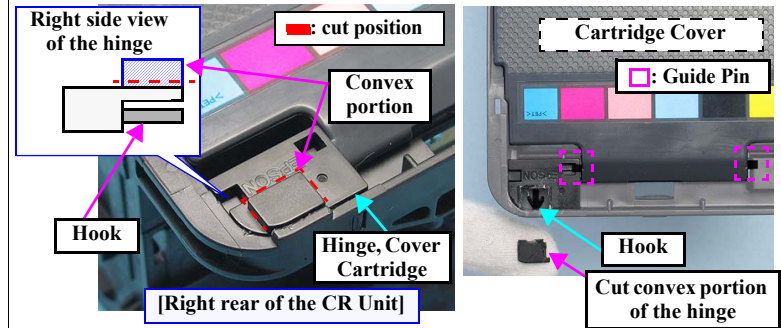

Figure 4-153. Removing the Cartridge Cover

4.5.13 Upper Paper Guide



- Be sure to follow the procedure below to remove the Upper Paper Guide to avoid damaging the PE Sensor Lever.
- It is recommended to place a transparent sheet between the Upper and Front Paper Guides to avoid scratching the roller.
- Do not touch the roller surface with bare hands as it can adversely affect the print quality.

- Parts/Components need to be removed in advance

All exterior parts/ All control boards / Middle Housing / Printer Mechanism / CR Scale / APG Unit / Printhead / Ink System / ASF Unit

- Removal procedure



Refer to the Orientation Definition below for the directions indicated in the following procedures.

•“4.1.6 Orientation Definition (p.61)”

1. Remove the three springs from the rear side, disengage the five hooks and remove the Upper Paper Guide from the Main Frame.

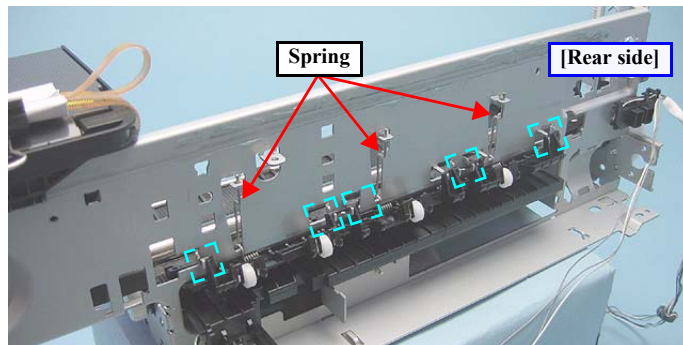

Figure 4-154. Removing the Upper Paper Guide (1)

2. Remove the Upper paper Guide pressing part to lower the tip of the PE Sensor Lever.

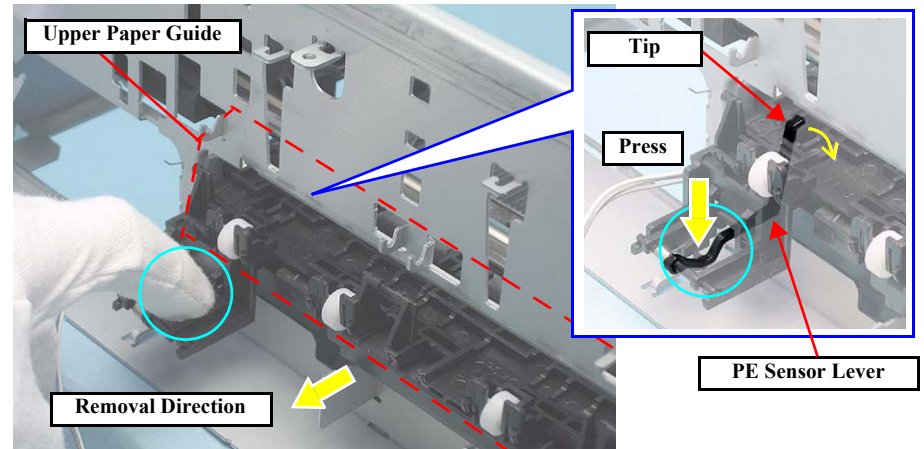
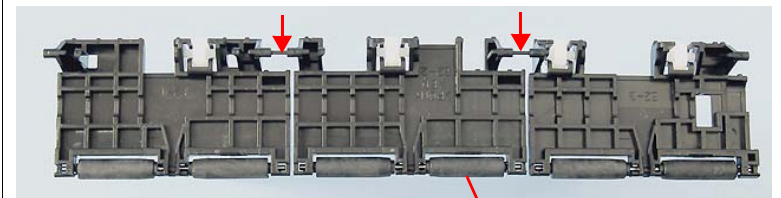

Figure 4-155. Removing the Upper Paper Guide (2)



The figure below is the Upper Paper Guide. The two thin shafts indicated with the arrows are likely to break, however, the Upper Paper Guide does not need to be replaced even if the shafts become broken. Because the shafts do not go on the bushings of the Printer Frame.



Do not touch with bare hands.



When installing the Spring, check the tip position of the spring and secure it firmly. (Fig.4-154)

4.5.14 Front Paper Guide Assy/APG Sensor Assy



Do not touch the surface of the rubber roller of the EJ Roller Assy and the coated part of the PF Roller Assy as it can adversely affect the print quality.

- Parts/Components need to be removed in advance
All exterior parts/components / All control boards / Middle Housing / Printer Mechanism / CR Scale / APG Unit / Printhead / Ink System / ASF Unit / Upper Paper Guide / CR Motor / EJ Frame Assy / PF Encoder / PF Scale / CR Unit

- Removal procedure



Refer to the Orientation Definition below for the directions indicated in the following procedures.
•“4.1.6 Orientation Definition (p.61)”

- Removing the Front Paper Guide Assy
 1. Remove the screw and remove the Parallelism Bushing L.
 - Screw ○ : C.B.S. M3x8 (tightening torque: 6-8 kgf.cm)

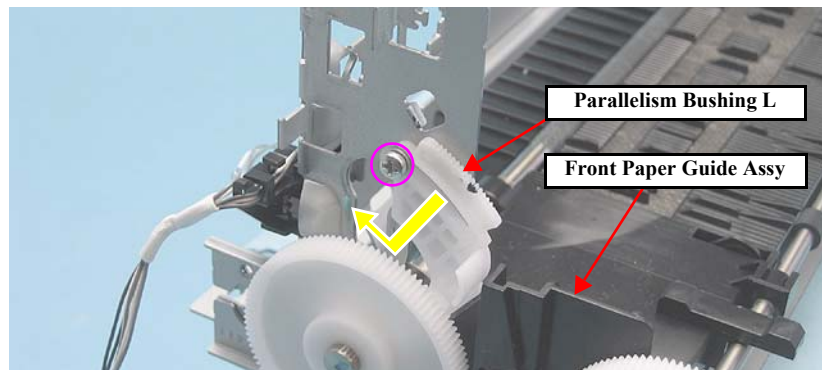

Figure 4-156. Removing the Parallelism Bushing L

2. Disconnect the connector of the PE Sensor Cable on the rear side of the printer.
3. Remove the screw that secures the Front Paper Guide Assy.
 - Screw ○ : C.B.S. M3x6 (tightening torque: 7-9 kgf.cm)

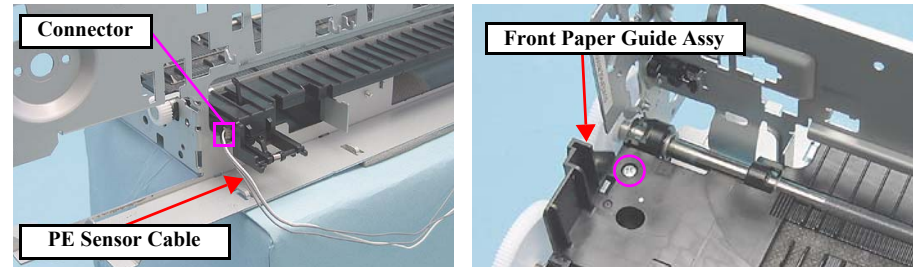

Figure 4-157. Removing the PE Sensor Cable

4. Pull out the EJ Ground Spring to the front side.

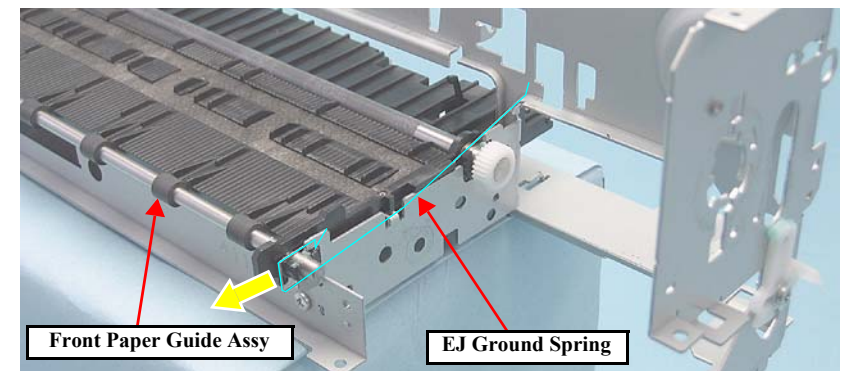



Figure 4-158. Removing the EJ Ground Spring

5. Remove the Front Paper Guide Assy, following the steps below.
 - (1) Lift  part to disengage the left side of the Front Paper Guide Assy.
 - (2) Slide the assy leftward little by little to disengage the right side of the assy.
 - (3) Remove the Front Paper Guide Assy while releasing its shaft from the cutout of the rib on the left side of the Main Frame.

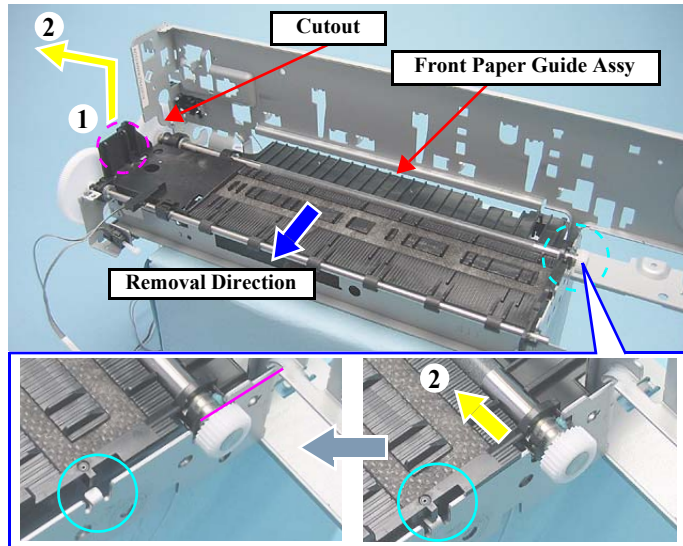

Figure 4-159. Removing the Front Paper Guide Assy

- Removing the APG Sensor Assy
 1. Disengage the two hooks and remove the APG Sensor Assy.

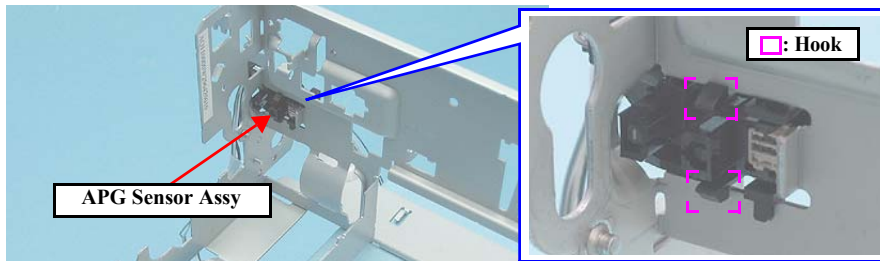

Figure 4-160. Removing the APG Sensor



- Lubrication is required. See the page given below for the lubrication information. **"6.1.3 Lubrication (p.131)"**
- When installing the Front Paper Guide Assy, pull out the CDR Tray Sensor cable as shown below.



Figure 4-161. Routing the CDR Tray Sensor Cable

- Attach the long foot of the EJ Ground Spring as follows; (1) put it through the gap under the portion contacts with the EJ Roller, (2) let it contact with the Main Frame, (3) let it contact with the PF Roller shaft, (4) put it through the hole on the frame. When finished, make sure the spring properly contacts with (1), (2), (3), and (4) points.

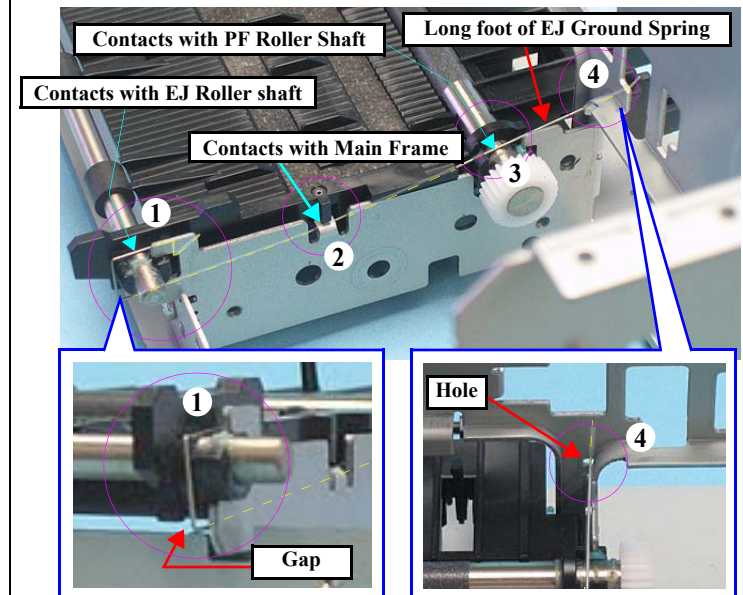

Figure 4-162. Attaching the EJ Ground Spring

- Be careful not to deform the EJ Ground Spring

4.5.15 CDR Guide Detection Assy

- Parts/Components need to be removed in advance

All exterior parts/components / All control boards / Middle Housing / Printer Mechanism / CR Scale / APG Unit / Printhead / Ink System / ASF Unit / Upper Paper Guide / Front Paper Guide Assy / CR Motor / EJ Frame Assy / PF Encoder / PF Scale / CR Unit



The CDR Guide Detection Assy consists of the CDR Guide Sensor, CDR Tray Sensor and the connector cables.

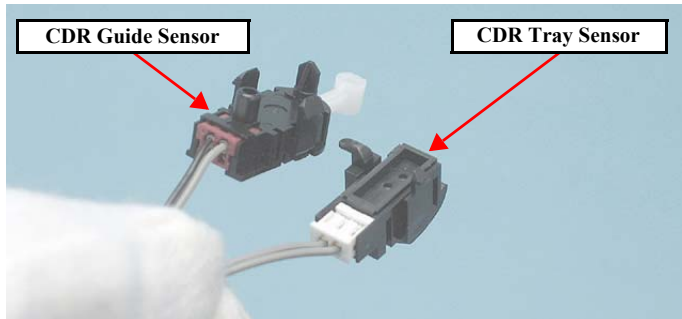

Figure 4-163. CDR Guide Detection Assy

- Removal procedure

1. Disengage the two hooks and remove the CDR Guide Sensor from the frame.

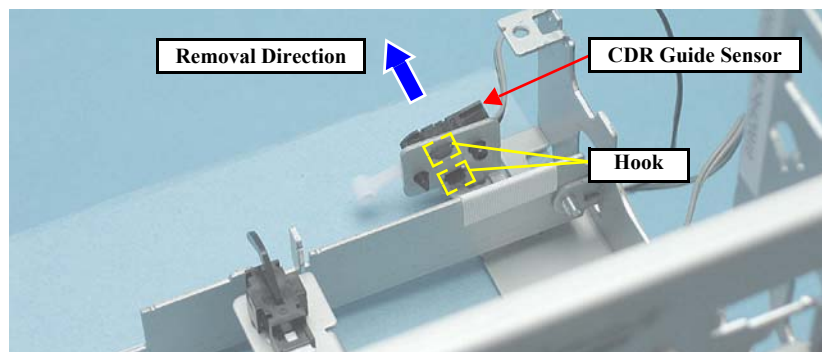

Figure 4-164. Removing the CDR Guide Sensor



Always follow the steps below to remove the CDR Tray Sensor, or one of its hooks can be broken.

2. Disengage the hook of the CDR Tray Sensor.
3. Turn the CDR Tray Sensor 90 degrees in the direction of the arrow to disengage its another hook, and pull it out from the hole to remove it together with the CDR Guide Sensor.

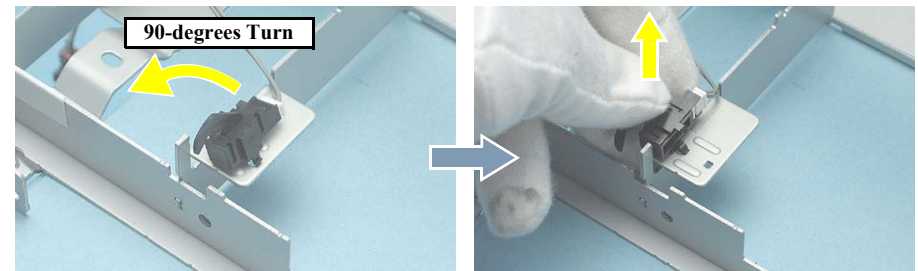
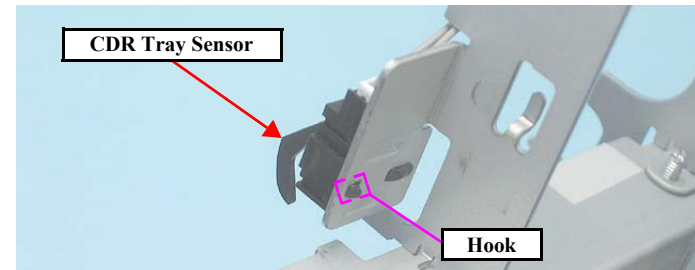

Figure 4-165. Removing the CDR Tray Sensor (CDR Guide Detection Assy)

CHAPTER

5

ADJUSTMENT

5.1 Adjustment Items and Overview

This chapter describes adjustments necessary after the disassembly/reassembly of the printer.

5.1.1 Servicing Adjustment Item List

The adjustment items of this product are as follows.

Table 5-1. Adjustment Items

	Function Item	Purpose	Method Outline	Tool	Used Media
Adjustment Items	PG Adjustment	Install the Head Nozzle surface parallel to the printing surface and set the gap between the paper and the Head Nozzle surface to the specified value.	Place a Thickness Gauge in the specified position, move the Timing Belt manually, and check by moving the Carriage with the Printhead installed sideways.	• Thickness Gauge 1.15mm, 1.3mm	--
	EEPROM data copy	This function is used to read the necessary data from the EEPROM of the faulty Main Board and write them to the new Main Board in order to reduce the auxiliary adjustment items at the time of Board replacement.	With the old Board installed, use the adjustment program to read out the EEPROM data, and after exchanging with the new Board, load the read out data.	• Adjustment Program	--
	Initial setting	At the time of Main Board replacement, this adjustment is made to write the Board common information of Initial setting.	Use the adjustment program to write the Board information of Initial setting to the Main Board.	• Adjustment Program	--
	Input Head ID	At the time of Printhead replacement, this adjustment is made to register the head manufacturing variations correction ID to the printer.	Use the adjustment program to input the Head QR Code label ID stuck on the Printhead. (Supplement: Read the QR code label from left to right on the top row and then from top to bottom in due order.)	• Adjustment Program	--
	Input USB-ID	To enable recognition of each printer on the PC side, when several same model printers are connected to the PC via the USB hub.	Enter the serial number to the adjustment program. The adjustment program automatically creates a unique ID from the serial number and is registered to the Printer.	• Adjustment Program	--
	Initialize PF Deterioration Offset	To initialize the PF deterioration offset value.	Use the adjustment program to execute Initialisation to initialize the PD deterioration offset value.	• Adjustment Program	--
	Disenable PF Deterioration Offset	To input the maximum value (3,000) of the PF deterioration offset value	Use the adjustment program to execute Input of the maximum value (3,000) of the PF deterioration offset value.	• Adjustment Program	--
	TOP Margin Adjustment	Correct the print timing by the software to make the start printing position of the sub scan direction to the value you wish.	Use the adjustment program, to print the Top margin adjustment pattern, measure the distance from Paper top edge to the TOP line, and adjust so that it becomes within 3 ± 1 mm.	• Adjustment Program • Rule	Post Card
	Head angular adjustment	Adjust the vertical/horizontal tilt that occur when installing the Head, by the software.	Use the adjustment program to print the adjustment pattern and adjust to meet the standard with various patterns.	• Adjustment Program	A4/Letter (Plain paper)

Table 5-1. Adjustment Items

	Function Item	Purpose	Method Outline	Tool	Used Media
Adjustment Items	Bi-D adjustment	This adjustment is made to correct the print timing in the go and return paths in bi-directional printing.	Use the adjustment program to print out the adjustment pattern, and enter the adjustment value of the printed pattern with no black/white streaks in the block.	• Adjustment Program	A4/Letter (Plain paper)
	First dot/PW adjustment	<input type="checkbox"/> First dot adjustment Correct the print timing by the software to make the start printing position of the main scan direction to the value you wish.	Use the adjustment program to print the adjustment pattern and enter the adjustment value of printed position 5mm from the left edge.	• Adjustment Program • Rule	A4/Letter (Glossy paper)
		<input type="checkbox"/> PW adjustment This adjustment is made to correct the mounting position of the PW Sensor on a software basis to adjust the detection position and Nozzle position dispersion.	Use the adjustment program to print out the adjustment pattern, and for each of the 4 sides, enter the adjustment value of the printed line that was 5mm from the paper edge.		
	PF adjustment	This adjustment is made to correct the variations of Mechanism, or the paper feeding accuracy.	Use the adjustment program to print out the adjustment pattern, evaluate the pattern based on the criteria, and register the appropriate adjustment value to the printer.	• Adjustment Program	A4/Letter (Glossy paper)
	BRS/PFP adjustment	This adjustment is made to ensure high print quality at high print speed. For more details, see “2.3 Banding Reduction System (BRS) / Paper Feed Amount Profile Correction (PFP) (p.30)	Print the adjustment pattern to be scanned by a specified scanner. According to the scanned result, a correction value is automatically calculated and stored into the serial flash ROM on the main board. The correction value is applied when printing in the corresponding mode.	• Specified Scanner • PFP base scale	A4 (Matte Paper-Heavyweight) 4 x 6 (Premium Glossy Photo Paper)
CR motor heat protection control	When the Main Board and/or CR Motor is replaced individually, write the maximum value of the correction value to prevent motor damage when the CR Motor generates heat.	Select this function in the exclusive servicing program, and check the replaced part among those indicated below. <input type="checkbox"/> CR Motor <input type="checkbox"/> Main Board <input type="checkbox"/> PF Scale <input type="checkbox"/> Printer Mechanism According to the checked part, the program automatically makes adjustment. The correction value is saved into the EEPROM.	• Adjustment Program	--	

Table 5-2. Maintenance Items

Function Item		Purpose	Method Outline	Tool	Used Media
Maintenance Items	Head Cleaning	This function is used to execute Cleaning efficiently when ink is not delivered from the Head properly, e.g. dot missing.	Use the adjustment program to execute Cleaning, then execute nozzle check printing.	• Adjustment Program	A4/Letter (Plain paper)
	Waste ink pad protection counter reset	Initialize the Waste ink pad counter for replaced parts after maintenance error occurred. Also, when counter full is close, pad exchange/counter initialization may be executed to prevent re-fixing.	After exchanging the Waste ink pad, initialize the counter by the adjustment program.	• Adjustment Program	--
	Ink charge	When replacing the Head, this function is used to fill ink in the flow path of the Head in the ASP to make all nozzles printable and stabilize the ink in the Printhead.	Use the adjustment program to execute ink charge, then execute nozzle check printing.	• Adjustment Program	A4/Letter (Plain paper)

Table 5-3. Additional Functions

Function Item		Purpose	Method Outline	Tool	Used Media	
Additional Functions	Print check pattern	Glossy paper	This printing is executed to check whether all adjustment results are normal.	Select and execute the functions by the adjustment program.	• Adjustment Program	A4 (Glossy paper)
		Photo Quality Ink Jet Paper				Letter (Photo Quality Ink Jet Paper)
	EEPROM data readout		Read the EEPROM data for analysis.	Select this function in the exclusive servicing program, and save all data of the EEPROM into a file.	• Adjustment Program	--
	Read printer information	Manual CL counter	Read the printer operation information.	Select and execute the functions by the adjustment program.	• Adjustment Program	--
I/C exchange CL counter						
Timer CL counter						
Print pass counter						

5.1.2 Replacement Part Adjustment Items

The following table indicates the adjustment items for replacement parts.

Note: “Required” in this table indicates the adjustment item that must be executed when the corresponding part has been removed/replaced. “-” indicates that no adjustment is required. When you have removed/replaced two or more parts, refer to the corresponding items of all parts. Also, if there are several adjustment items for one exchanging part, execute the adjustment in the priority order mentioned in the table.

Table 5-4. Adjustment Items

Priority order		1	2	3	4	5	6	7	8	9	10	11	12	13	14	15	16	17
		PG Adjustment	EEPROM Data Copy	Destination Setting	USB ID	Head ID	Waste ink pad Counter	Ink Charge	Initialize PF Deterioration Offset	Disenable PF Deterioration Offset	TOP Margin Adjustment	Head Angular Adjustment	Bi-D Adjustment	First Dot Adjustment	PW Adjustment	PF Adjustment	BRS/PFP Adjustment	CR Motor Heat Protection Control
ASF Unit	Remove	--	--	--	--	--	--	--	--	--	Required	--	--	Required	--	Required	Required	--
	Replace	--	--	--	--	--	--	--	--	--	Required	--	--	Required	--	Required	Required	--
CR Motor	Remove	--	--	--	--	--	--	--	--	--	--	--	Recommended	Recommended	--	--	--	--
	Replace	--	--	--	--	--	--	--	--	--	--	--	Recommended	Required	--	--	--	Required
Upper Paper Guide	Remove	--	--	--	--	--	--	--	--	--	Required	--	--	--	--	Required	Required	--
	Replace	--	--	--	--	--	--	--	--	--	Required	--	--	--	--	Required	Required	--
Printhead	Remove	Required	--	--	--	--	--	--	--	--	Required	Required	Required	Required	Required	Required	Required	--
	Replace	Required	--	--	--	Required	--	Required	--	--	Required	Required	Required	Required	Required	Required	Required	--
Main Board	Remove	--	--	--	--	--	--	--	--	--	--	--	--	--	--	--	--	--
	Replace (Copy OK)	--	Required	--	--	--	--	--	--	--	--	--	--	--	--	--	--	Required
	Replace (Copy NG)	--	--	Required	Required	Required	Required (Ink Pads must be replaced)	--	--	Required	Required	Required	Required	Required	Required	Required	Required	Required
PS Board	Remove	--	--	--	--	--	--	--	--	--	--	--	--	--	--	--	--	--
	Replace	--	--	--	--	--	--	--	--	--	--	--	--	--	--	--	--	Required
Front Paper Guide Assy (including PF Shaft)	Remove	Required	--	--	--	--	--	--	--	--	Required	Required	Required	Required	Required	Required	Required	--
	Replace	Required	--	--	--	--	--	--	--	Required	Required	Required	Required	Required	Required	Required	Required	--
PF Motor	Remove	--	--	--	--	--	--	--	--	--	--	--	--	--	--	Recommended	Recommended	--
	Replace	--	--	--	--	--	--	--	--	Required	--	--	--	--	--	Required	Required	--

Table 5-4. Adjustment Items

Priority order	1	2	3	4	5	6	7	8	9	10	11	12	13	14	15	16	17
	PG Adjustment	EEPROM Data Copy	Destination Setting	USB ID	Head ID	Waste ink pad Counter	Ink Charge	Initialize PF Deterioration Offset	Disable PF Deterioration Offset	TOP Margin Adjustment	Head Angular Adjustment	Bi-D Adjustment	First Dot Adjustment	PW Adjustment	PF Adjustment	BRS/PFP Adjustment	CR Motor Heat Protection Control
Waste Ink Tray	Remove	--	--	--	--	--	--	--	--	--	--	--	--	--	--	--	--
	Replace	--	--	--	--	Required (Waste Ink Tray)	--	--	--	--	--	--	--	--	--	--	--
Waste Ink Pad	Remove	--	--	--	--	--	--	--	--	--	--	--	--	--	--	--	--
	Replace	--	--	--	--	Required (Waste Ink pad)	--	--	--	--	--	--	--	--	--	--	--
CR Unit	Remove	Required	--	--	--	--	--	--	--	Required	Required	Required	Required	Required	Required	Required	--
	Replace	Required	--	--	--	--	--	--	--	Required	Required	Required	Required	Required	Required	Required	--
Paper Eject Frame Assy	Remove	--	--	--	--	--	--	--	--	--	--	--	--	--	Required	Required	--
	Replace	--	--	--	--	--	--	--	--	--	--	--	--	--	Required	Required	--
Printer Mechanism	Remove	--	--	--	--	--	--	--	--	--	--	--	--	--	--	--	--
	Replace	Required	--	--	--	--	--	Required	--	Required	Required	Required	Required	Required	Required	Required	Required

5.2 Adjustment by Using Adjustment Program

This section explains how to judge print samples by using the adjustment program. Follow the instructions of the adjustment program for details of the adjustment methods.

5.2.1 Top Margin Adjustment

Patterns are printed as shown below.

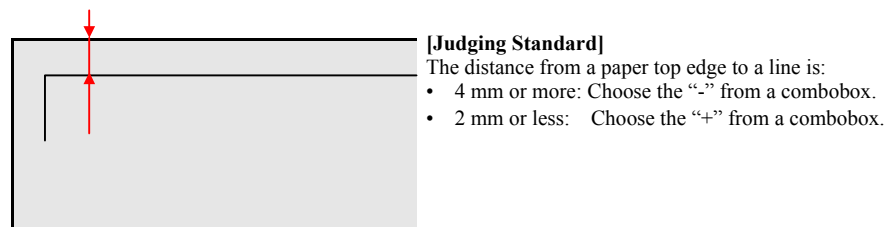

Figure 5-1. Top Margin Adjustment Printing Pattern

[Judgement method]

Measure the distance from Paper top edge to the adjustment line, and enter any one of the “-”, “0”, “+” according to the judging standard.

5.2.2 Head angular adjustment

Two patterns are printed as shown below.

Band pattern

Pattern shown below is printed for both 0 to 80 column and 80 to 0 column printing direction.

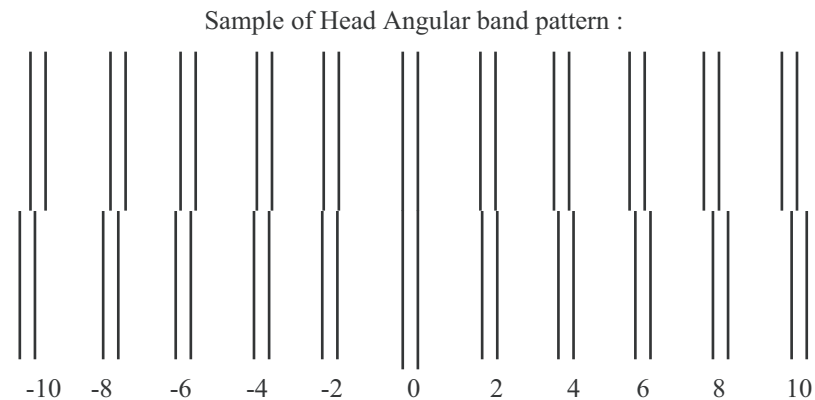

Figure 5-2. Head angular adjustment Pattern Printing (1)

[Judgment method]

Find the pattern with least vertical displacement between -10 and 10, and enter the value of that pattern.

[Corrective action]

If the “NG” on both ends are the ones with least vertical displacement, reassemble/replace the Head, and carry out the adjustment again.



The diagram below shows the OK and NG patterns.

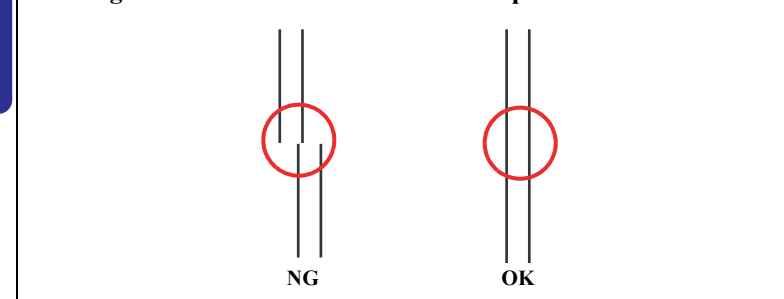

□ Microweave Pattern

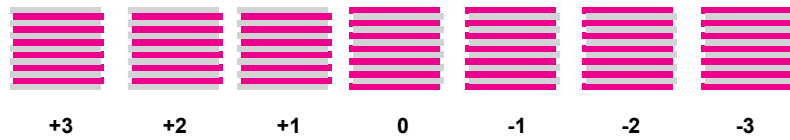

Figure 5-3. Head angular adjustment Pattern Printing (2)

[Judgment method]

Examine the printout +3 to -3 patterns and select the value for the group of which the gaps between the 2 color bars are the smallest.

[Corrective action]

If no appropriate pattern is found, reassemble/replace the Print Head.

CHECK
POINT

The diagram below shows the OK and NG patterns.

OK

NG

5.2.3 Bi-D Adjustment

The pattern shown below is printed for each of the 4 print modes.

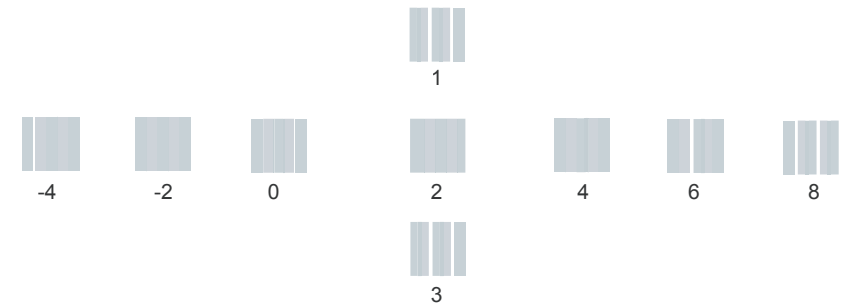

Figure 5-4. Bi-D adjustment Pattern Printing

[Judgment method]

Find the pattern with no gaps or overlaps of the left and right pattern, and enter the value of that pattern.

[Corrective action]

If an appropriate pattern is not printed, enter the nearest value and then print the patterns again.

CHECK
POINT

The diagram below shows the OK and NG patterns.

NG

OK

NG

5.2.4 PW Adjustment/First Dot Adjustment

Patterns are printed as shown below.

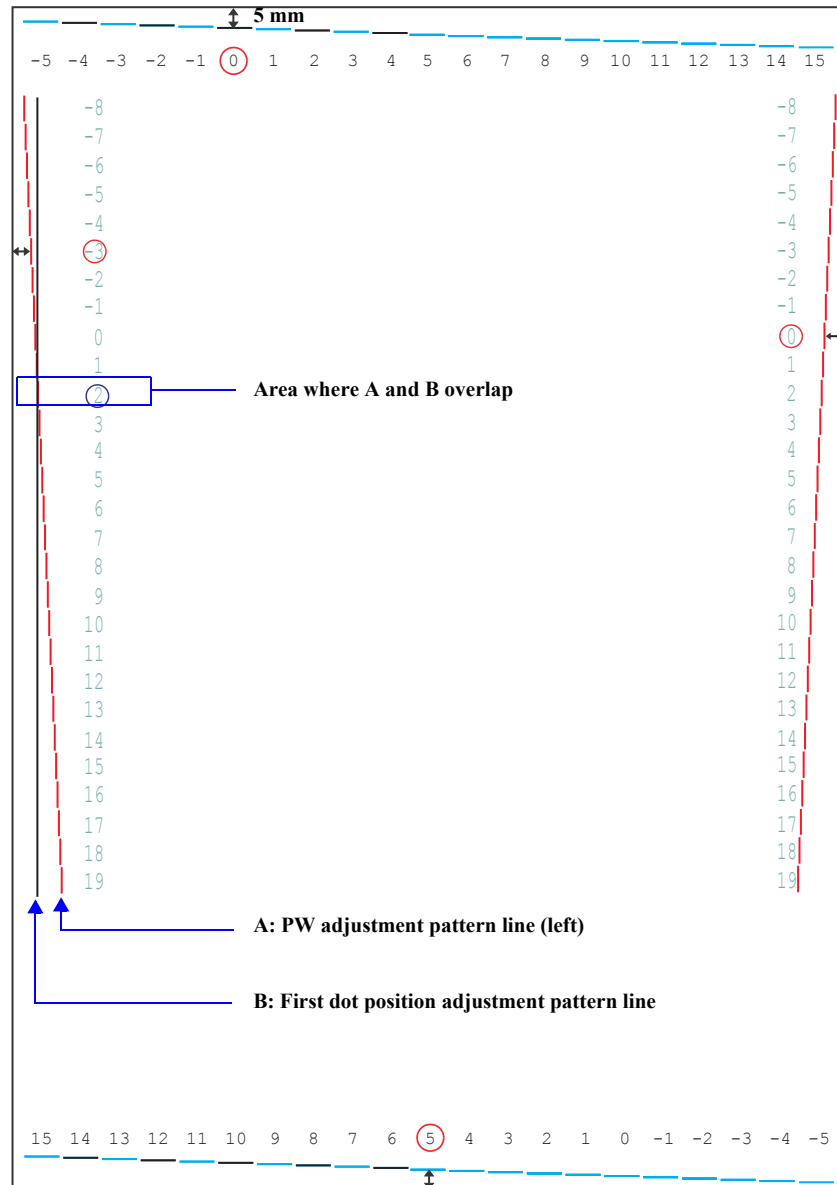

Figure 5-5. Left Right margin adjustment Pattern Printing

- PW adjustment

[Judgment method]

Enter the value of the line located 5mm away from each edge.

Example: In the left figure, enter “0” (top), “0” (right), “5” (bottom) and “-3” (left).

- First dot adjustment

[Judgment method]

Enter the value of the area where the PW adjustment pattern line and the First dot position adjustment pattern line overlap on the left of the paper.

Example: In the left figure, enter “2” since the lines overlap in Position “2”.

5.2.5 PF Adjustment

□ PF-Standard Area

Patterns are printed as shown below.

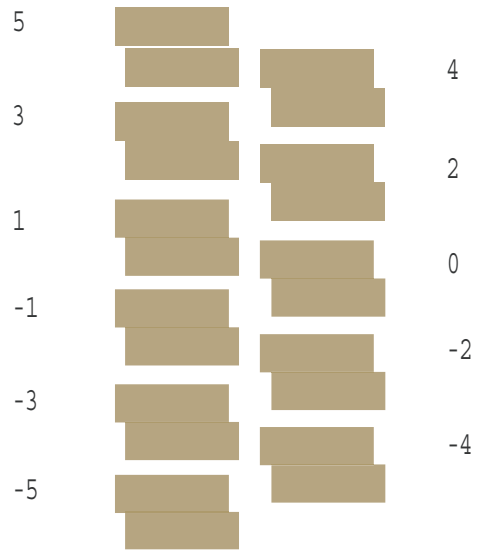
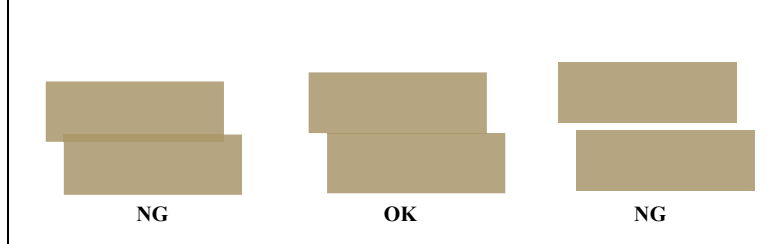

Figure 5-6. PF adjustment (Standard Area) Pattern Printing

[Judgment method]

Input the value shown above the patterns which has no gap between the upper pattern and the lower pattern, and also the both upper and lower patterns do not overlap each other.

The diagram below shows the OK and NG patterns.



□ PF-Bottom Edge Area

Patterns are printed as shown below.

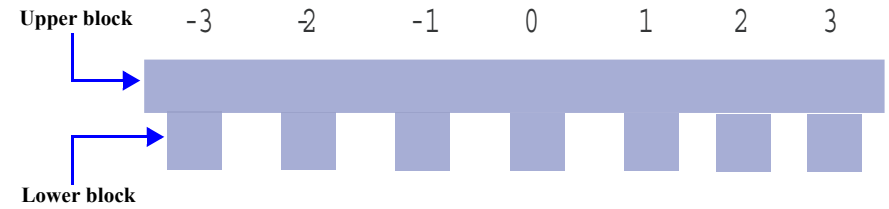

Figure 5-7. PF adjustment (Bottom Edge Area) Pattern Printing

[Judgment method]

Input the value shown above the patterns which has no gap between the upper pattern and the lower pattern, and also the both upper and lower patterns do not overlap each other.

Example: In the above figure, patterns below “0” has no gap and overlap, so input “0”.

[Corrective action]

In case that all patterns have gap or overlap, choose the pattern which has the least gap or overlap, and print the pattern again after inputting the value.

The diagram below shows the OK and NG patterns.

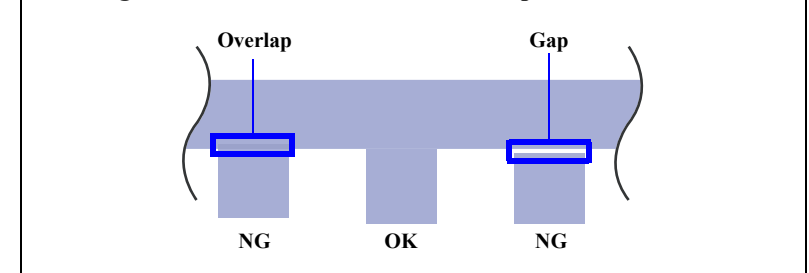

5.2.6 PG Adjustment

Described below is the platen gap (PG) adjustment.

- Purpose:
Adjust the distance between the head surface and the Paper Guide Front Assy (platen) properly and adjust the parallelism on the 0th column side and on the 80th columns side to ensure reliable print quality.
Once the Carriage Assy and/or Adjustment Bushes have been removed or whenever necessary for any other reason, make this adjustment to correct the deviation of the platen gap.

Table 5-5. PG Positions

Position	PG Size (mm)	Application for Printing (selected from PG flag list for normal/head rubbing)	Sequence Application
PG- <APG Home>	1.2	EPSON special thick paper PGPP, Postcards, Matte, etc.	Cleaning CR measurement, VH detection CR home position seek
PG typ. <Mechanical default>	1.7	Plain paper EPSON special thin paper, SF, etc. Rubbing with PG1.2 is avoided	
PG+	2.35	Envelopes Rubbing with PG1.2 and 1.7 is avoided	
PG++	4.2	CD-R printing	At ink replacement

- Things to be used
 - Thickness gauge: 1.15 mm (x2)
1.3 mm (x2)
 - Phillips screwdriver



- The thickness gauge to be used must be free from dust and dirt and from deformation. Be sure to clean it before use.
- Take care that the Print Head is not soiled or scratched.
- To ensure high accuracy of adjustment, install new ink cartridges in the carriage, and move the carriage right and left by pulling the belt without holding the carriage.



- Make this adjustment after installing the mechanism unit in the Housing Lower. (Install the Linear Scale after adjustment.) Refer to “4.4 Removing the Printer Mechanism” (p.87)
- With EPSON Stylus Photo R260/R265/R270, R360/R380/R390, four stages of PG setting are available by means of the APG Mechanism. However, make this adjustment with the mechanism in the minimum PG position (PG-: 1.2 mm). (Refer to “4.5.2 APG Unit” (p.90) and below.)

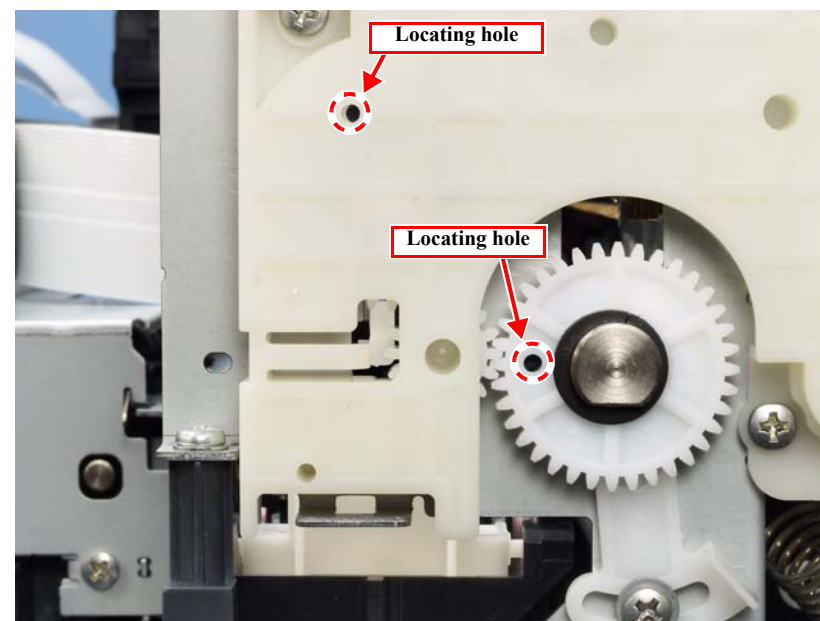

Figure 5-8. PG Position at PG Adjustment

□ Adjustment procedure

- Specified PG value: 1.2 ± 0.1 mm

1. Install new ink cartridges in the carriage.
2. Remove the Cable Holder Frame. (Fig. 4-128)
3. Check that the APG Assy and the carriage are in the PG-position. (Fig. 5-18)
4. Move the carriage to the center of the platen, and place 1.15 mm thickness gauge on the left aligning its left edge with the second rib of the Front Paper Guide. And place another 1.15 mm thickness gauge on the right aligning its right edge with the rightmost rib of the Front Paper Guide. (Fig. 5-9)

NOTE: The thickness gauge must not be set over the leftmost rib on the Front Paper Guide.

5. Pull the Timing Belt to move the carriage to the left end.
6. If the carriage comes in contact with the gauge, adjust the Left Parallelism Bush to raise the carriage to a position where the Printhead does not come in contact with gauge.
7. Pull the Timing Belt to move the carriage to the right end.
8. If the carriage comes in contact with the gauge, adjust the Right Parallelism Bush to raise the carriage to a position where the Printhead does not come in contact with gauge.
9. Move the carriage to the middle area of the platen, and place 1.3 mm thickness gauges at the left and right ends of the platen.
10. Pull the Timing Belt to move the carriage to the left end.
11. If the carriage does not come in contact with the gauge, make the adjustment again.
12. Pull the Timing Belt to move the carriage to the right end.
13. If the carriage does not come in contact with the gauge, make the adjustment again.
14. Mark the indicated graduation position of the right and left Parallelism Bush, and tighten the screws.
(Screw tightening torque: 0.8 ± 0.1 N•m)

CAUTION

The Printhead must come in contact with the 1.3 mm thickness gauges but must not come in contact with the 1.15 mm thickness gauges.

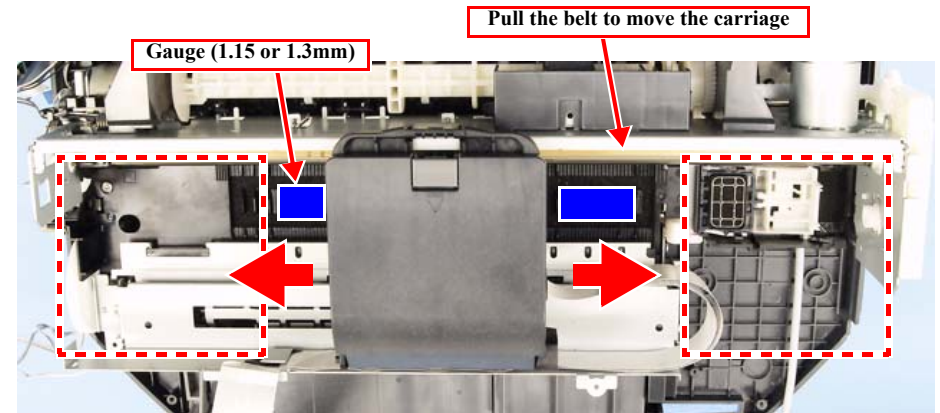

Figure 5-9. PG Adjustment 1

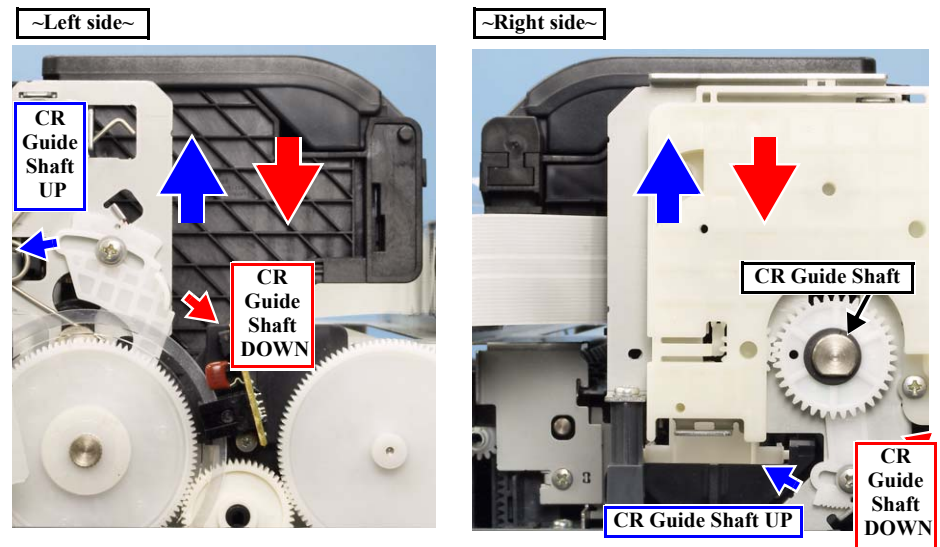

Figure 5-10. PG Adjustment 2

5.3 Banding Reduction System (BRS) Adjustment/ Paper Feed Amount Profile (PFP) Correction

5.3.1 Overview

This section explains how to carry out BRS/PFP adjustments.



- For overview of BRS/PFP Adjustment, refer to Chapter 2 “2.3 Banding Reduction System (BRS) / Paper Feed Amount Profile Correction (PFP) (p. 30)
- Be sure to have a specified scanner ready beforehand as it is necessary to carry out the adjustment. Before scanning, confirm that the document table is free from any dirt or stain.

- Tools and paper required to perform the adjustment

Table 5-6. Tools and Paper for BRS/PFP Adjustment

	Tools/Paper	Product Code
Common	PFP Base scale	1453980
BRS	Matte Paper-Heavyweight (A4)	---
PFP	Premium Glossy Photo Paper (4 x 6)	---

- Specified Scanner to perform the adjustment



- Install the driver of the scanner to the PC in advance.
- As the profile required for the adjustment is not prepared for scanners other than the ones specified below, BRS/PFP Adjustment can not be carried out by the other scanners.

The following are the scanners that can be used for scanning the pattern in BRS/PFP adjustment. When starting up the adjustment program, select the scanner to use.

Table 5-7. Specified Scanner for BRS/PFP Adjustment

Model Name	Sensor type	Remarks
Perfection 4490 Photo	CCD	
Perfection V700 Photo	CCD	
Stylus Photo RX520/RX530, Stylus CX7700/CX7800	CIS	Use the internal scanner.
Stylus Photo RX560/RX580/RX590	CIS	Use the internal scanner.



Depending on the sensor type of the scanner to use for the adjustment, drying time required after the BRS adjustment pattern has been printed differs. For PFP adjustment pattern/PFP check pattern, drying time is not required.

- For “CCD” sensor:
Printed pattern can be scanned straight away. (Drying time of about 2 minutes is recommended.)
- For “CIS” sensor:
Printed pattern needs to be dried more than 5 minutes.

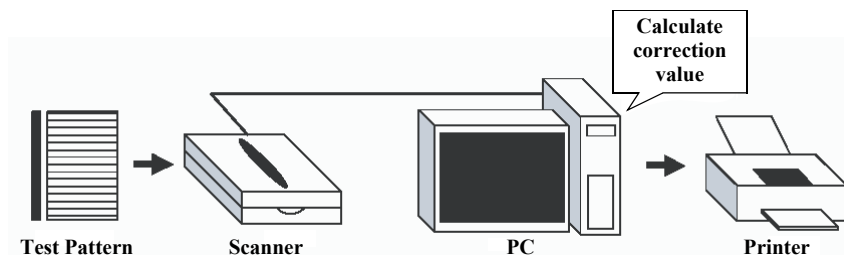

Figure 5-11. System Configuration

□ Adjustment Flow

Carry out the adjustment following the adjustment flow below.

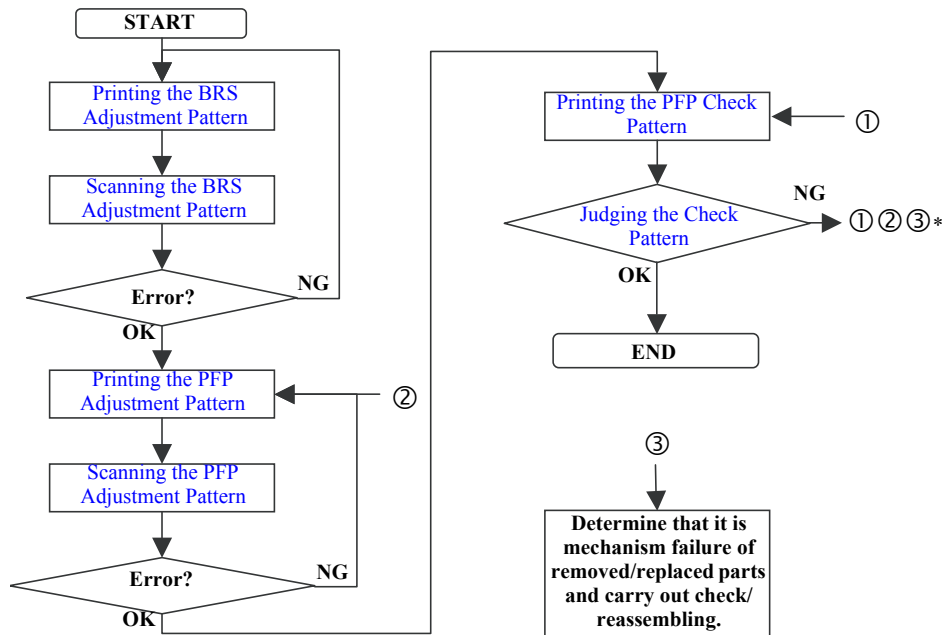

Figure 5-12. BRS/PFP Adjustment Flow

Note*: When a PFP pattern is judged as NG, repeat the steps as described below.
 First time NG: retry from ① step
 Second time NG:retry from ② step
 Third time NG: perform ③ step



When an error is displayed in the Adjustment program, check the points below, then carry out the adjustment again. If an error occurs even after checking the points below, change the scanner with a different one and carry out the adjustment again.

1. Check that the printer that printed the pattern and the printer to register the adjustment value is the same.
2. Check that the printed pattern is placed on the document table of the scanner correctly.
3. Check that there is no gap between the PFP Base Scale and the pattern printed sheet.
4. Check that the scanner glass surface and the PFP Base Scale is free from any dirt or dust.

5.3.2 Adjustment Procedure

5.3.2.1 BRS (Banding Reduction System) Adjustment

□ Printing the BRS Adjustment Pattern

1. Load A4 size Matte Paper-Heavyweight on the paper support.
2. Select [BRS Adjustment] in the adjustment program.
3. Click the [Print] button on the “1. Print Test Pattern” column to print the adjustment pattern.
4. Let the printed pattern dry for more than 5 minutes if using CIS sensor type scanner.

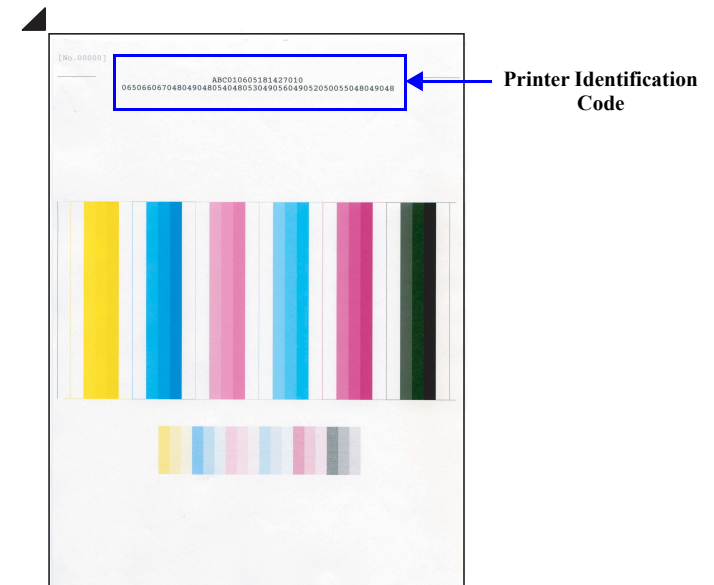

Figure 5-13. BRS Test Pattern



- In the Adjustment program, the identification code is used to distinguish whether the printer that printed the pattern and the printer to register the adjustment value is the same.
- Make sure to let the printed pattern dry for more than 5 minutes if using CIS sensor type scanner. When using CCD sensor type scanner, the printed pattern does not need to be dried before scanning. Refer to “Table 5-7. Specified Scanner for BRS/PFP Adjustment” (p.124)

- Scanning the BRS Adjustment Pattern
- 5. Set the printed pattern and the PFP Base Scale on the document table and click the [Scan] button on the “3. Scan Test Pattern” column.
- 6. According to the scanned result, BRS calibration values are automatically calculated and are written to the serial flash ROM. If an error occurs, check that the document table glass and the scale is clean, and the scale/adjustment pattern is not tilted, then repeat from step 5.

CAUTION

! Be careful of the following when setting the PFP Base Scale, and the adjustment pattern on the scanner.

- Place the scale on the document glass aligning the scale corner with the scanner origin position.
- Place the pattern-printed sheet along the scale as shown in the figure below. Make sure to place it parallel to the scale, with no gaps.

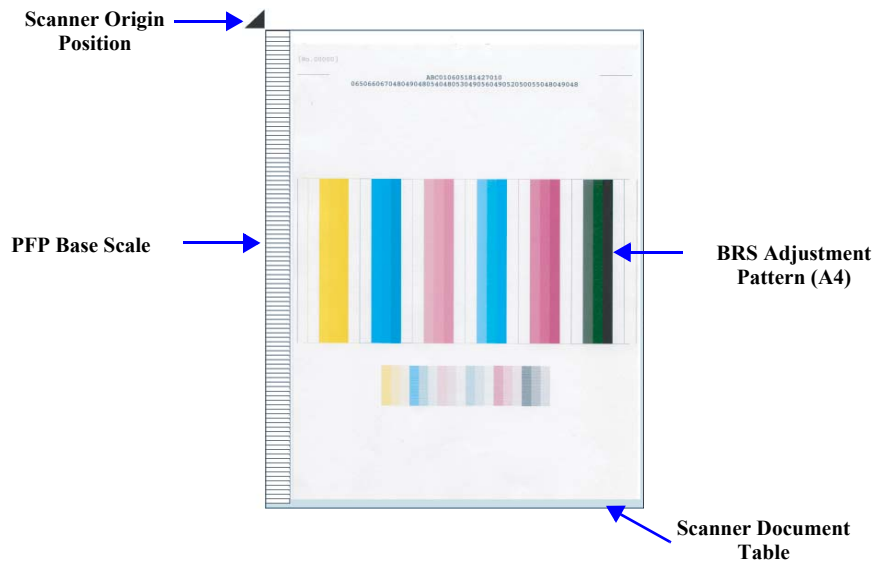

Figure 5-14. PFP Base Scale and BRS Adjustment Pattern Position (Viewed from the document glass of the scanner)

5.3.2.2 PFP Adjustment

- Printing the PFP Adjustment Pattern
- 1. Load 4 x 6 Premium Glossy Photo Paper on the paper support.
- 2. Select [PFP Adjustment] in the adjustment program.
- 3. Click the [Print] button on the “1. Print Test Pattern” column to print the adjustment pattern.

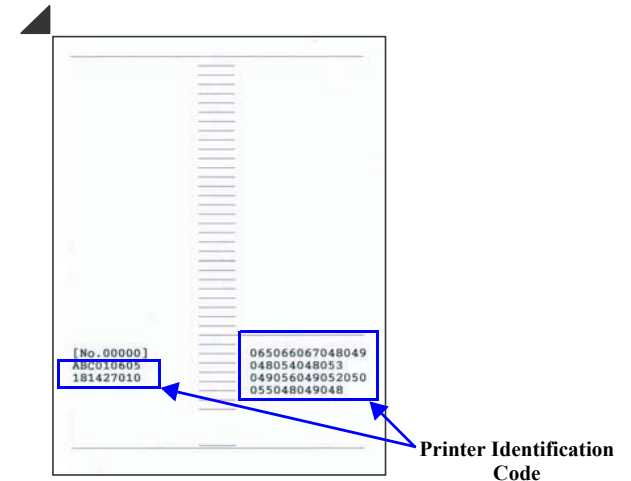

Figure 5-15. PFP Test Pattern

CHECK POINT

✓ In the Adjustment program, the identification code is used to distinguish whether the printer that printed the pattern and the printer to register the adjustment value is the same.

- Scanning the PFP Adjustment Pattern
- 4. Set the PFP Base Scale and the PFP test pattern on the document table and click the [Scan] button on the “3. Scan Test Pattern” column.
- 5. According to the scanned result, PFP calibration values are automatically calculated and are written to the serial flash ROM. If an error occurs, check that the document table glass and the scale is clean, and the scale/adjustment pattern is not tilted, then repeat from step 4.

CAUTION

Be careful of the following when setting the PFP Base Scale and the adjustment pattern on the scanner.

- Place the scale on the document glass aligning the scale corner with the scanner origin position.
- Place the pattern-printed sheet along the scale as shown in the figure below. Make sure to place it parallel to the scale, with no gaps.

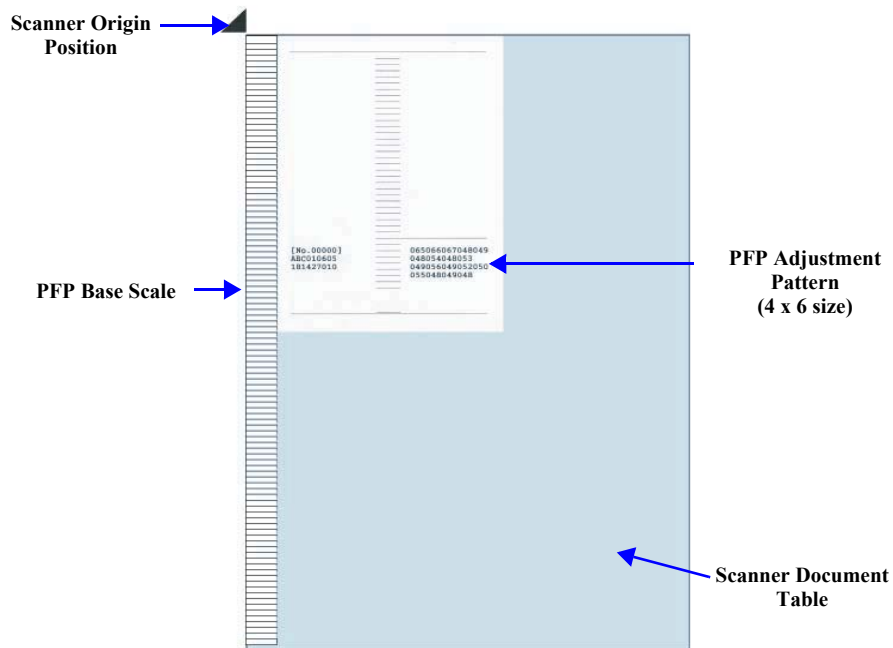

Figure 5-16. PFP Base Scale and PFP Adjustment Pattern Position (When viewed from the document glass of the scanner)

- Printing the PFP Check Pattern
- 6. Set 4 x 6 Premium Glossy Photo Paper on the paper support and click the [Print] Button on the “4. Print Check Pattern” column.

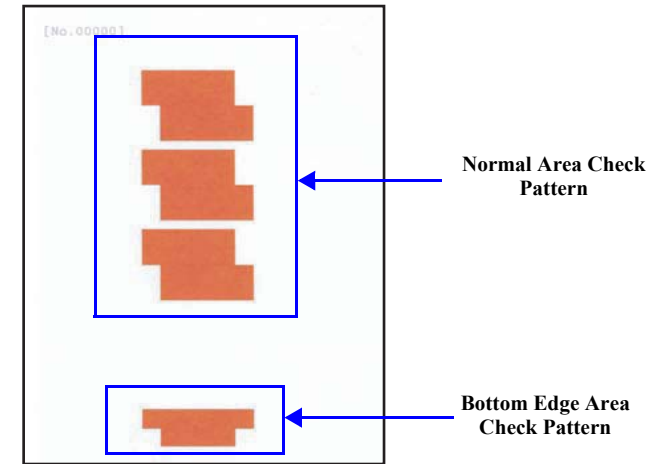

Figure 5-17. PFP Check Pattern

- Judging the Check Pattern
- 7. Referring to [Fig. 5-18](#) check that there is no white or overlapped bands in all the check patterns. If any bands are found, carry out the steps below.
 1. Re-print the check pattern to see if the bands appear again.
 2. When bands appear in Step 1, try the PFP adjustment again from the beginning.
 3. When bands appear even after the re- adjustment in step 2, determine that it is the mechanism failure and carry out check/reassemble of the parts that was removed/replaced.

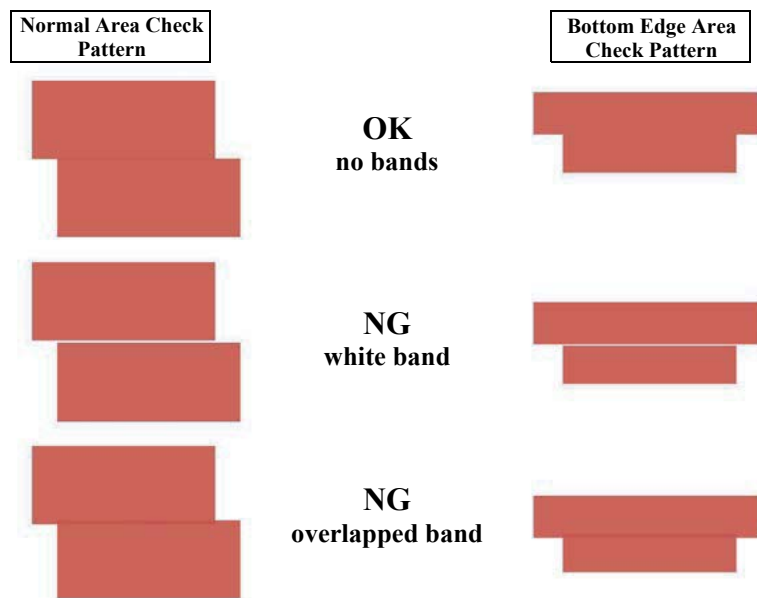

Figure 5-18. PFP Check Pattern Judging Standard

CHAPTER

6

MAINTENANCE

6.1 Overview

This section provides information to maintain the printer in its optimum condition.

6.1.1 Cleaning

This printer has no mechanical components which require regular cleaning except the Print Head. Therefore, when returning the printer to the user, check the following parts and perform appropriate cleaning if stain is noticeable.

CAUTION

- **Never use chemical solvents, such as thinner, benzine, and acetone to clean the exterior parts of the printer like the Housing. These chemicals may deform or deteriorate the components of the printer.**
- **Be careful not to damage any components when you clean inside the printer.**
- **Do not scratch the coated surface of the PF Roller Unit. Use soft brush to wipe off any dusts.**
- **Use a soft cloth moistened with alcohol to remove the ink stain.**
- **When using compressed air products; such as air duster, for cleaning during repair and maintenance, the use of such products containing flammable gas is prohibited.**

- Exterior parts
Use a clean soft cloth moistened with water, and wipe off any dirt. If the exterior parts have ink stain, use a cloth moistened with neutral detergent to wipe it off.
- Inside the printer
Use a vacuum cleaner to remove any paper dust.
- LD Roller
When paper loading function does not operate because of a drop in friction force of the LD Roller due to paper dust, use a soft cloth moistened with alcohol to remove the paper dust.

6.1.2 Service Maintenance

If any abnormal print (dot missing, white line, etc.) has occurred or the printer indicates the “Maintenance request error”, take the following actions to clear the error.

(This error is displayed in EPSON Status Monitor 3 and in the LCD Panel for R360/R380/R390, and with LED for R260/R265/R270.)

6.1.2.1 Print Head cleaning

When dot missing or banding appears on images, run the Print Head cleaning cycle.* The cleaning be activated from the control panel, the printer driver utility or the Adjustment program.

Note *: This printer has three manual cleaning modes. The appropriate cleaning mode is automatically selected and performed according to various conditions. The ink consumption amount for manual cleaning varies depending on the mode.

6.1.2.2 Maintenance request error

Ink is consumed also for cleaning and flashing operations. When the ink is used for cleaning and flashing operations, the ink is drained to the Waste Ink Pads via the Pump. The amount of the waste ink is stored as the waste ink counter into the EEPROM. When the waste ink counter has reached the limit of the absorbing capability of the Waste Ink Pads, the maintenance request error is displayed. This printer takes the ink evaporation amount into consideration, therefore the counter limit differs depending on how often printing is made.

CHECK POINT

For display of Maintenance request error, see the following.

- **Chapter3 "Troubleshooting" (p.31)**

When the maintenance request error appears, replace the Waste ink pads with a new one and reset the waste ink counter using the Adjustment program. If the waste ink counter is close to its limit, recommend that the Waste ink pads will be replaced with new one. This is because the “Maintenance request error” will may occur after returning the repaired product to the customer.

6.1.3 Lubrication

The type and amount of the grease used to lubricate the printer parts are determined based on the results of the internal evaluations. Be sure to apply the specified type and amount of the grease to the specified parts during servicing mentioned below.

- When parts that need lubrication is been replaced
- As the need arises during disassembly/reassembly of the printer



■ Never use oil or grease other than those specified in this manual. Use of different types of oil or grease may damage the component and adversely affect the printer operation.

■ Observe the specified amount. Never apply excess.

Table 6-1. Specified Lubricant

Type	Name	EPSON code	Supplier
Grease	G-71	1304682	EPSON
Grease	G-77	1455324	EPSON

- Refer to the following figures for the lubrication points.

LUBRICATION OF DRIVEN PULLEY

	<p><Lubrication Points> Four points where contact with the Main Frame</p> <p><Type> G-71</p> <p><Application Amount> ø 1 x 4 mm x 4 points</p> <p><Application Timing> Apply before installing the Driven Pulley</p> <p><Remarks> Apply with Injector</p>
--	---

Figure 6-1. Lubrication of Driven Pulley (1)

	<p><Lubrication Points> Two points on bushings for the Pulley Shaft One point at the center of the Pulley Shaft</p> <p><Type> G-71</p> <p><Application Amount> ø 1 x 1 mm x 3 points</p> <p><Application Timing> Apply before installing the Driven Pulley</p> <p><Remarks> Apply with Injector</p>
--	---

Figure 6-2. Lubrication of Driven Pulley (2)

	<p><Lubrication Points> Two points on the side of the Pulley</p> <p><Type> G-71</p> <p><Application Amount> ø 1 x 1 mm x 2 points</p> <p><Application Timing> Apply after installing the Driven Pulley</p> <p><Remarks> Apply with Injector</p>
--	---

Figure 6-3. Lubrication of Driven Pulley (3)

LUBRICATION OF FRONT PAPER GUIDE ASSY

<p style="text-align: center;">Front Paper Guide Assy (left)</p>  <p style="text-align: center;">Application Point</p>	<p><Lubrication Points> PF Roller Shaft, EJ Roller Shaft and Bushing (3 points)</p> <p><Type> G-71</p> <p><Application Amount> ø 1 x 3 mm x 3 points</p> <p><Application Timing> Apply after installing the Front Paper guide</p> <p><Remarks> Apply with Injector <input type="checkbox"/> Make sure that the coated part of the PF Roller Shaft and rubber rollers on the EJ Roller are free from grease.</p>
---	---

Figure 6-4. Lubrication of Front Paper Guide Assy (1)

<p style="text-align: center;">Front Paper Guide Assy (right)</p>  <p style="text-align: center;">Application Point</p> <p style="text-align: center;">Application Point</p>	<p><Lubrication Points> PF Roller Shaft, EJ Roller Shaft and Bushing (2 points)</p> <p><Type> G-71</p> <p><Application Amount> ø 1 x 3 mm x 2 points</p> <p><Application Timing> Apply after installing the Front Paper guide</p> <p><Remarks> Apply with Injector <input type="checkbox"/> Make sure that the coated part of the PF Roller Shaft and rubber rollers on the EJ Roller are free from grease.</p>
---	---

Figure 6-5. Lubrication of Front Paper Guide Assy (2)

LUBRICATION OF EJ FRAME ASSY

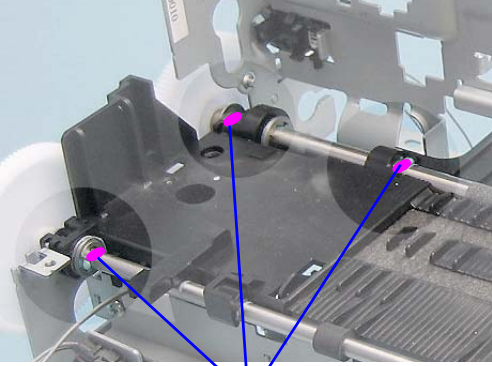
<p style="text-align: center;">EJ Frame Assy Bushing</p> <div style="display: flex; justify-content: space-around;"> <div style="text-align: center;"> <p>Left</p>  </div> <div style="text-align: center;"> <p>Right</p>  </div> </div> <p style="text-align: center;">Application Point</p>	<p><Lubrication Points> EJ Frame Assy Busing (Left/Right back side)</p> <p><Type> G-71</p> <p><Application Amount> ø1 x 1mm x 2 points (Right busing, both inner sides) ø1 x 3mm x 2 points (Left busing, both inner sides)</p> <p><Application Timing> Apply before installing the EJ Frame</p> <p><Remarks> Apply with Injector <input type="checkbox"/> Apply to the both inner sides of the left/right bushings.</p>
---	--

Figure 6-6. Lubrication of EJ Frame Assy

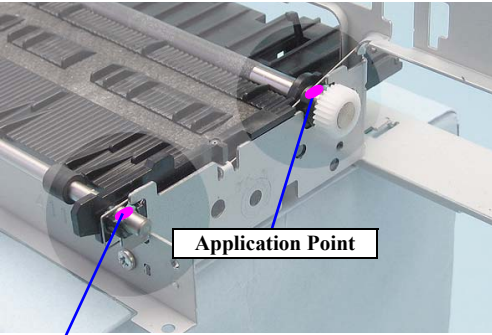
<p style="text-align: center;">Front Frame contact point (left)</p>  <p style="text-align: center;">Application Point</p>	<p><Lubrication Points> Contact point between the Front Frame and the PE Frame Assy (2 points)</p> <p><Type> G-71</p> <p><Application Amount> ø1 x 7mm (Left rib) ø1 x 3mm (Left notch for spring)</p> <p><Application Timing> Apply before installing the Front Frame</p> <p><Remarks> Apply with Injector <input type="checkbox"/> Apply to the inner edge of the notch for spring.</p>
---	---

Figure 6-7. Lubrication of the Front Frame (1)

<p>Front Frame contact point (right)</p>	<p><Lubrication Points> Contact position of the Front Frame and the PE Frame Assy (2 points)</p>
	<p><Type> G-71</p> <p><Application Amount> ø1 x 7mm (Right rib) ø1 x 3mm (Right Spring Bushing)</p> <p><Application Timing> Apply before installing the Front Frame</p> <p><Remarks> Apply with Injector <input type="checkbox"/> Apply to the inner edge of the notch for spring.</p>

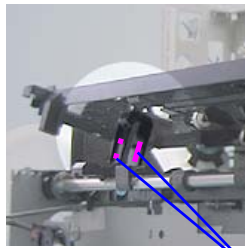
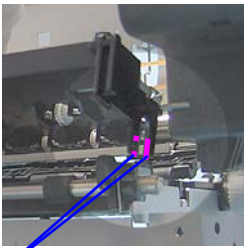
Figure 6-8. Lubrication of the Front Frame (2)

LUBRICATION OF CR UNIT

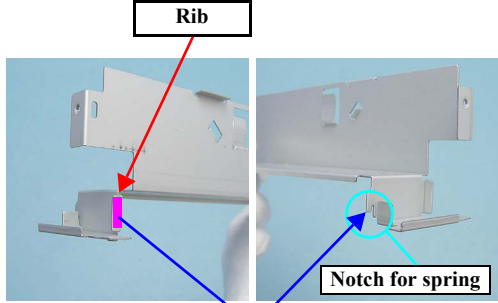
<p>Main Frame (upper rear)</p>	<p><Lubrication Points> On the back of the Main Frame where contact with the CR Unit</p>
	<p><Type> G-71</p> <p><Application Amount> 160 ± 20mg</p> <p><Application Timing> Apply after installing the CR Unit</p> <p><Remarks> Apply with Injector <input type="checkbox"/> Do not apply to the both ends (40mm from edge) <input type="checkbox"/> Move the CR Unit the left/right to spread the grease evenly.</p>
	

Figure 6-9. Lubrication of the Main Frame (1)

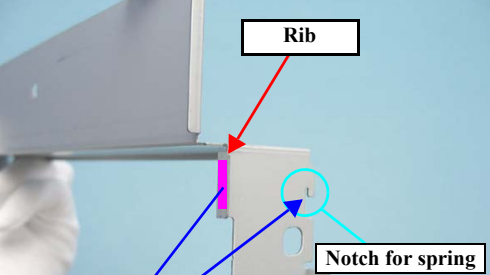
<p>PG Cam on both ends of CR Shaft</p>	<p><Lubrication Points> On the PG Cams attached to the both ends of the CR Shaft</p>
	<p><Type> G-71</p> <p><Application Amount> ø 1 x 5mm x 3 points</p> <p><Application Timing> Apply after installing the CR Shaft</p> <p><Remarks> Apply with Injector</p>

Figure 6-10. Lubrication of the CR Shaft PG Cam

<p>CR Shaft Retaining Spring</p>	<p><Lubrication Points> On the both ends of the CR Shaft to where its retaining springs are attached.</p>
	<p><Type> G-71</p> <p><Application Amount> ø 1 x 5 mm x 2 points</p> <p><Application Timing> Apply before installing the Spring</p> <p><Remarks> Apply with Injector</p>

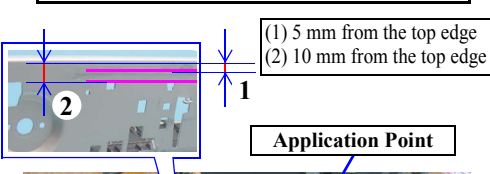
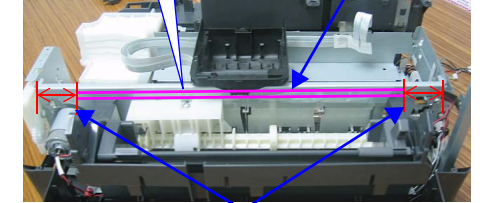
Figure 6-11. Lubrication for the CR Shaft Retaining Spring

<p>Contact point between CR Unit and CR Shaft (1)</p>  <p>CR Shaft</p> <p>Application Point</p>	<p><Lubrication Points> Contact point between CR Unit and the CR Shaft</p> <p><Type> G-71</p> <p><Application Amount> 210 ± 20mg x 2 points</p> <p><Application Timing> Apply before installing the CR Unit</p> <p><Remarks> Apply with Injector <input type="checkbox"/> After lubrication, move the CR Shaft to left and right by 60mm while rotating it, to spread the grease evenly. <input type="checkbox"/> Make sure that the Timing Belt is free from grease.</p>
---	---

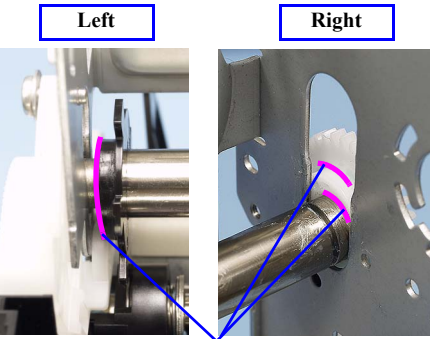
Figure 6-12. Lubrication of the CR Shaft (1)

<p>Contact point between CR Unit and CR Shaft (2)</p>  <p>CR Shaft</p> <p>Application Point: Apply from the holes</p>	<p><Lubrication Points> Lubrication holes of the Carriage Unit</p> <p><Type> G-71</p> <p><Application Amount> 210 ± 20mg x 2 points</p> <p><Application Timing> Apply before installing the CR Unit</p> <p><Remarks> Apply with Injector <input type="checkbox"/> Apply grease from the two lubrication holes. <input type="checkbox"/> Make sure that the Timing Belt is free from grease.</p>
--	---

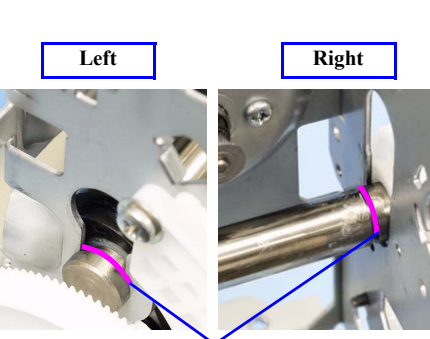
Figure 6-13. Lubrication of the CR Shaft (2)

LUBRICATION OF INK SYSTEM

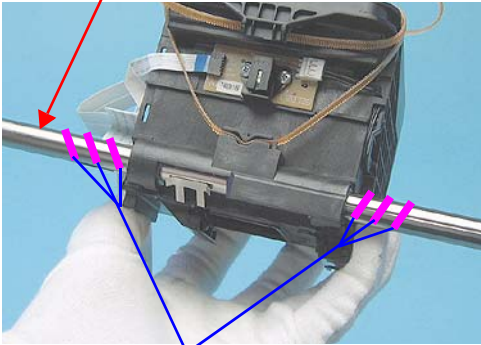
<p>Contact point between Main Frame and I/S</p>  <p>Application Point</p>	<p><Lubrication Points> On the Main Frame where the clutch gear and spring of the Ink System contact</p> <p><Type> G-71</p> <p><Application Amount> ø 1 x 1 circle</p> <p><Application Timing> Apply before installing the Ink System</p> <p><Remarks> Apply with Injector</p>
---	--

Figure 6-14. Lubrication of the I/S

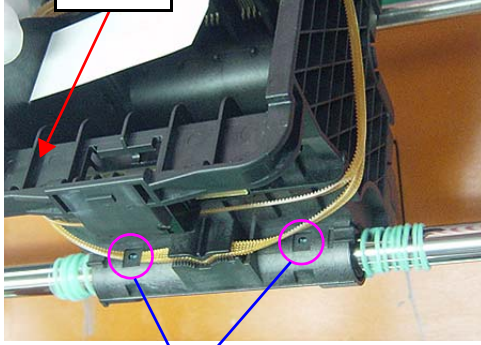
LUBRICATION OF APG UNIT

<p>Dowels on APF Unit</p>  <p>Application Point</p> <p>Dowel</p> <p>Application Point</p>	<p><Lubrication Points> Around the upper part of the dowels on the APG Unit. (5 points)</p> <p><Type> G-71</p> <p><Application Amount> ø 1 x 1 circle x 5 points</p> <p><Application Timing> Disassemble the APG Unit to apply the grease before installing it.</p> <p><Remarks> Apply with Injector</p>
--	--

Figure 6-15. Lubrication of the APG Unit (1)

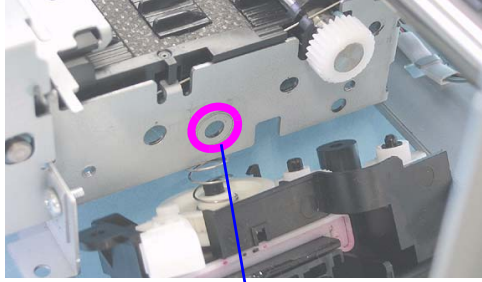
<p>Rim of the APG Unit Spur Gear 28.8</p>	<p><Lubrication Points> Around the rim of the Spur Gear 28.8</p>
	<p><Type> G-71</p>
<p>Application Point</p>	<p><Application Amount> ø 1 x 1 circle</p>
<p><Application Timing> Apply before installing the APG Unit</p>	<p><Remarks> Apply with Injector</p>

Figure 6-16. Lubrication of the APG Unit (2)

<p>LD Roller Shaft (Curved surface)</p>		<p><Lubrication Points> Contact point between the LD Roller Shaft and the Hopper, ASF Gear</p>
<p>USB I/F side</p>	<p>Clutch side</p>	<p><Type> G-71</p>
		<p><Application Amount> ø 1 x 10mm x 3 points</p>
<p>Application Point</p>	<p>Application Point</p>	<p><Application Timing> Apply before installing the ASF Unit</p>
		<p><Remarks> Apply with Injector <input type="checkbox"/> Rotate the LD Roller Shaft so that the Curved/Flat surface face up, then apply grease to the specified parts.</p>

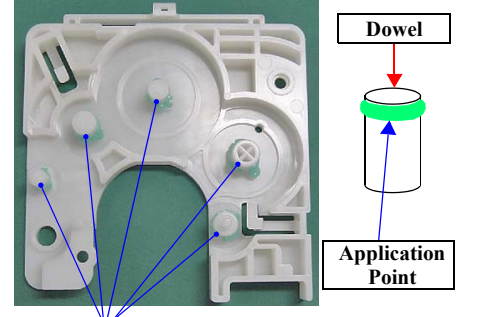
Figure 6-18. Lubrication of the LD Roller Shaft (1)

LUBRICATION OF ASF UNIT

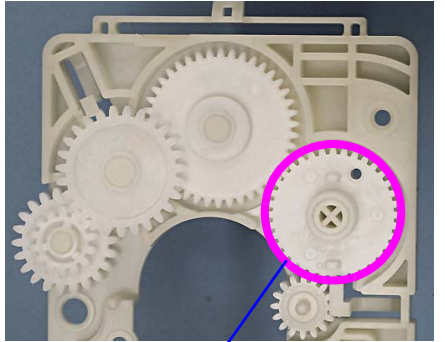
<p>Hole for LD Roller on ASF Unit</p>	<p><Lubrication Points> Inner edge of the hole on the ASF Unit where the LD Roller Shaft is put through</p>
	<p><Type> G-71</p>
<p>Application Point</p>	<p><Application Amount> 1 to 2 circles (inner edge) x 2 points</p>
<p><Application Timing> Apply before installing the LD Roller Assy</p>	<p><Remarks> Apply with Cotton bud</p>

Figure 6-17. Lubrication of the ASF Unit

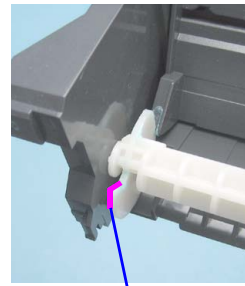
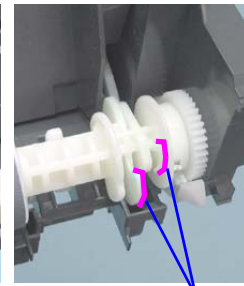
<p>LD Roller Shaft (Flat surface)</p>		<p><Lubrication Points> Contact point between the LD Roller Shaft and the Hopper, ASF Gear</p>
<p>USB I/F side</p>	<p>Clutch side</p>	<p><Type> G-71</p>
		<p><Application Amount> (1) ■ :ø 1 x 20mm x 2 points (2) ■ :ø 1 x 10mm</p>
<p>Application point (1)</p>	<p>Application point (2)</p>	<p><Application Timing> Apply before installing the ASF Unit</p>
		<p><Remarks> Apply with Injector <input type="checkbox"/> Rotate the LD Roller Shaft so that the Curved/Flat surface face up, then apply grease to the specified parts.</p>

Figure 6-19. Lubrication of the LD Roller Shaft (2)

<div style="border: 1px solid black; padding: 5px; width: fit-content; margin-bottom: 10px;"> LD Roller Shaft (Curved surface) (Ribs beside the LD Roller) </div>  <div style="border: 1px solid black; padding: 2px; width: fit-content; margin-top: 10px;"> Application Point </div>	<p><Lubrication Points> Contact point between the LD Roller and Hopper, ASF Gear</p>
	<p><Type> G-71</p>
	<p><Application Amount> ø 1 x 1/4-circle x 4 points</p>
	<p><Application Timing> Apply before assembling the LD Roller Holder</p>
	<p><Remarks> Apply with Injector <input type="checkbox"/> Rotate the LD Roller Shaft so that the Curved/Flat surface face up, then apply grease to the specified parts.</p>

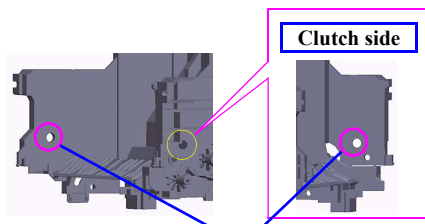
Figure 6-20. Lubrication of the LD Roller Shaft (3)

LUBRICATION OF LEFT/RIGHT STACKER GUIDE

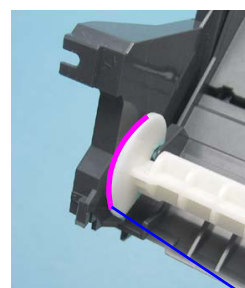
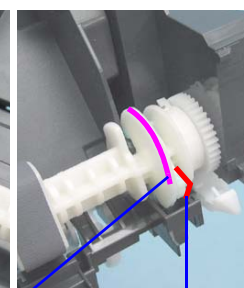
<div style="display: flex; justify-content: space-around; margin-bottom: 10px;"> <div style="border: 1px solid black; padding: 2px; font-size: small;">Left Stacker Guide</div> <div style="border: 1px solid black; padding: 2px; font-size: small;">Right Stacker Guide</div> </div>  <div style="border: 1px solid black; padding: 2px; width: fit-content; margin-top: 10px;"> Application Point </div>	<p><Lubrication Points> Along the groove of the Left/Right Stacker Guides to where the CDR Guide Shaft is set.</p>
	<p><Type> G-77</p>
	<p><Application Amount> Inner side of the groove x 2 points</p>
	<p><Application Timing> Apply before assembling the CDR Guide Shaft</p>
	<p><Remarks> Apply with flux dispenser</p>

Figure 6-21. Lubrication of the Stacker Guides

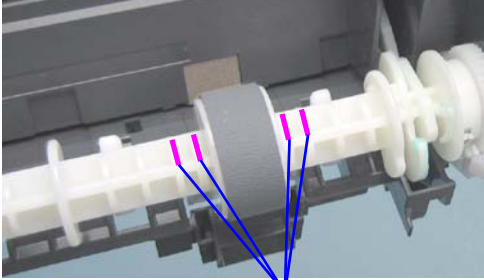
CHAPTER

7

APPENDIX

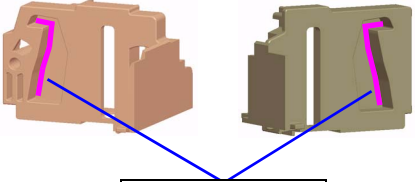
7.1 Exploded Diagram / Parts List

This manual does not provide exploded diagrams or parts list.

For the information, see SPI (Service Parts Information).

7.2 Electrical Circuits

The electric circuit diagrams below are shown at the following pages:

- Stylus Photo R360/R380/R390
 - Main Board (1) (C658 MAIN)
 - Main Board (2) (C658 MAIN)
 - Main Board (3) (C658 MAIN)
 - Main Board (4) (C658 MAIN)
 - Panel Board (C658 PNL)
 - Panel B Board (C658 PNL-B)
 - STG Board (C658 STG)
- Stylus Photo R260/R265/R270
 - Main Board (C653 MAIN)
 - Panel Board (C653 PNL)
 - IF Board (C653 IF)
- Stylus Photo R260/R265/R270/R360/R380/R390
 - Power Board (C653 PSB)
 - Power Board (C653 PSE)
 - Head Board (C653 HEAD)

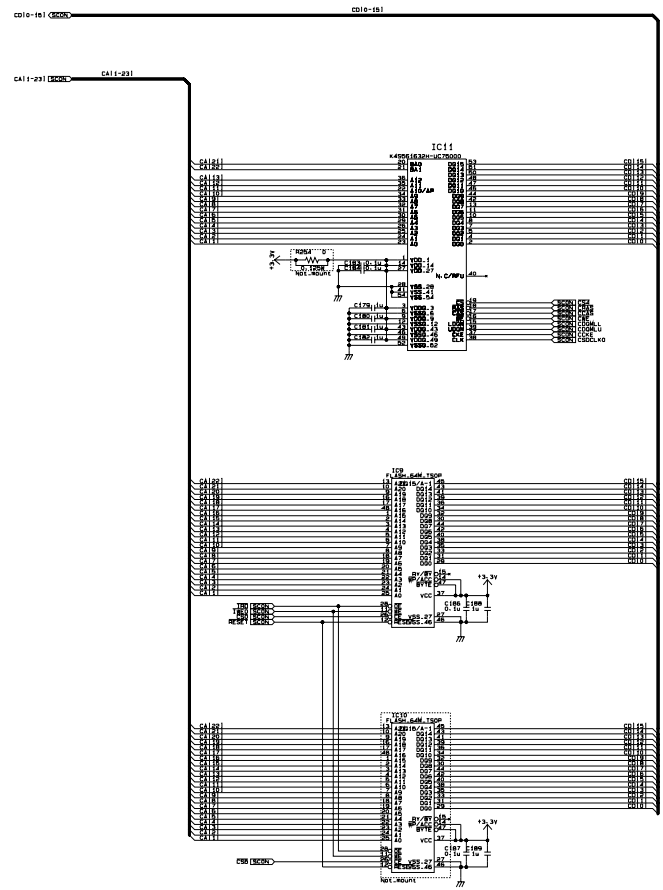
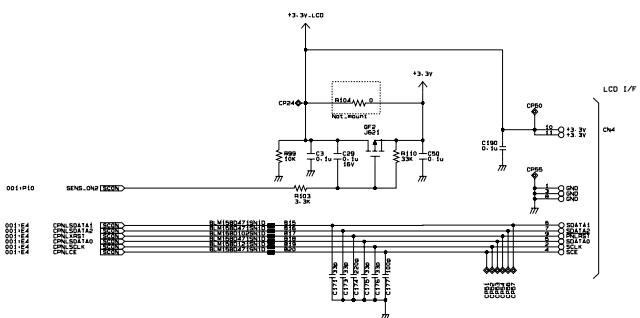
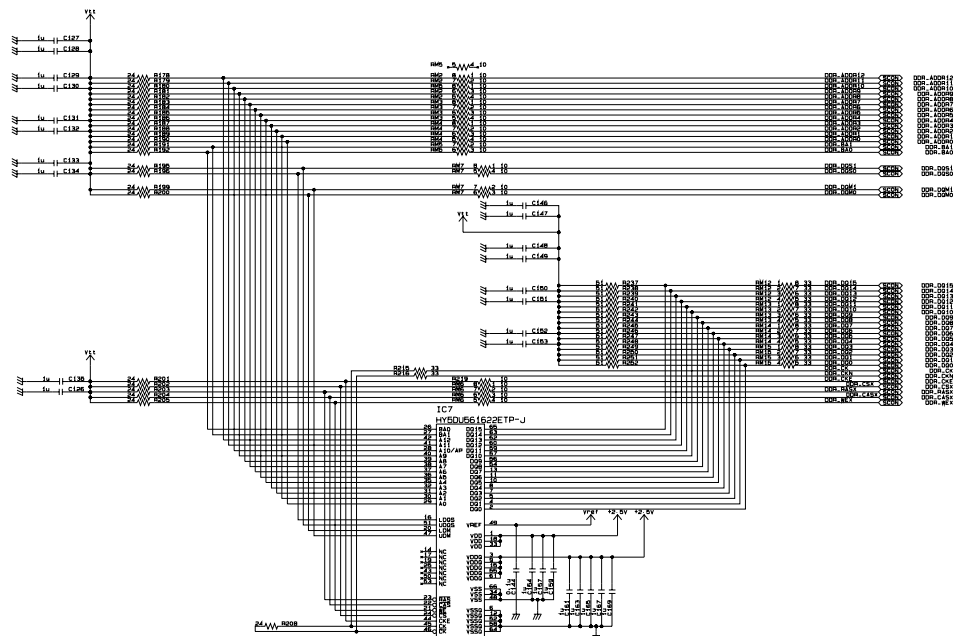

Model : PM-D870
 Stylus Photo R360/R380/R390
 Board : C658 MAIN
 Rev. : C
 Sheet : 2/4

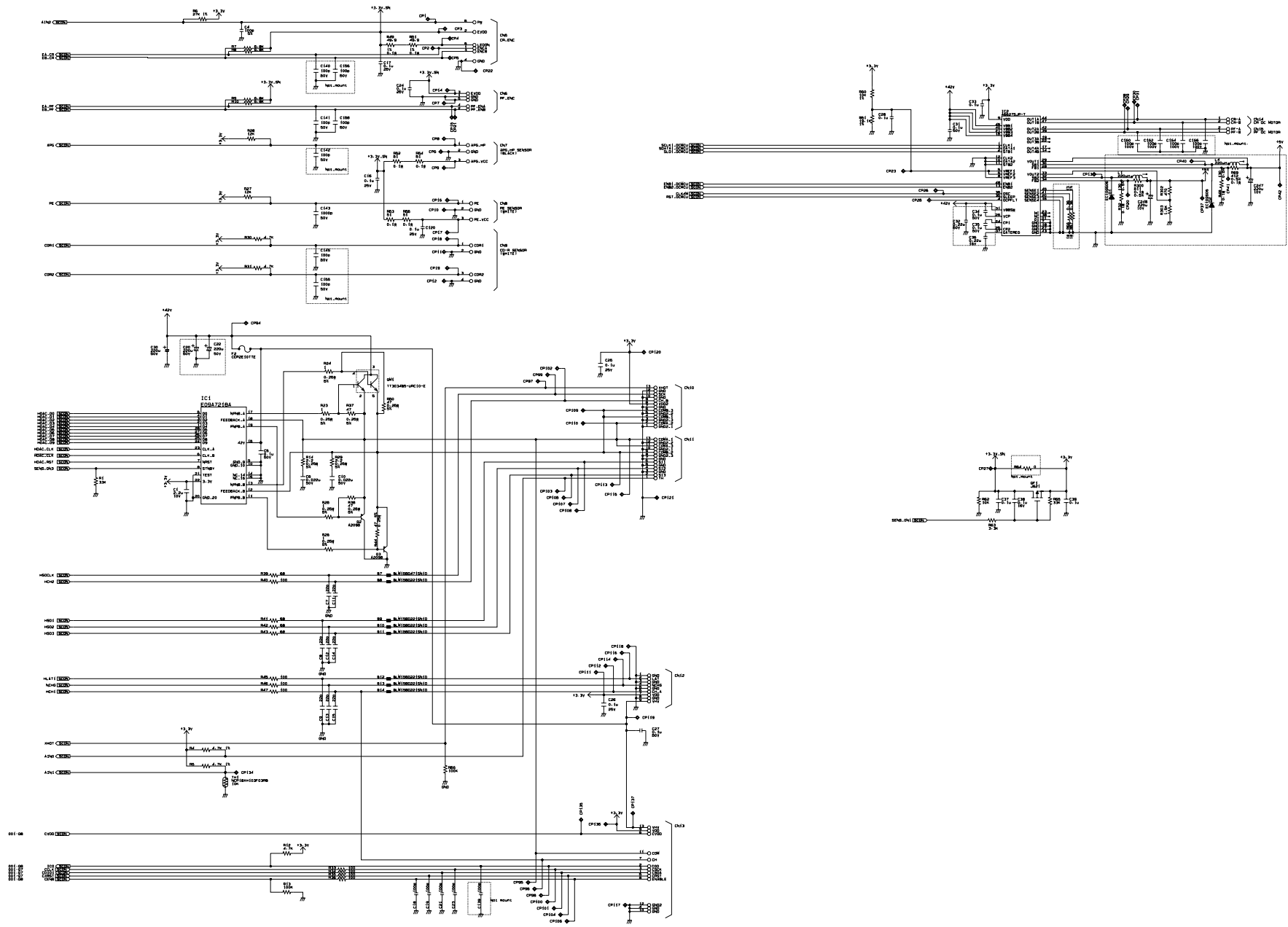

Model : PM-D870
 Stylus Photo R360/R380/R390
 Board : C658 MAIN
 Rev. : B
 Sheet : 3/4

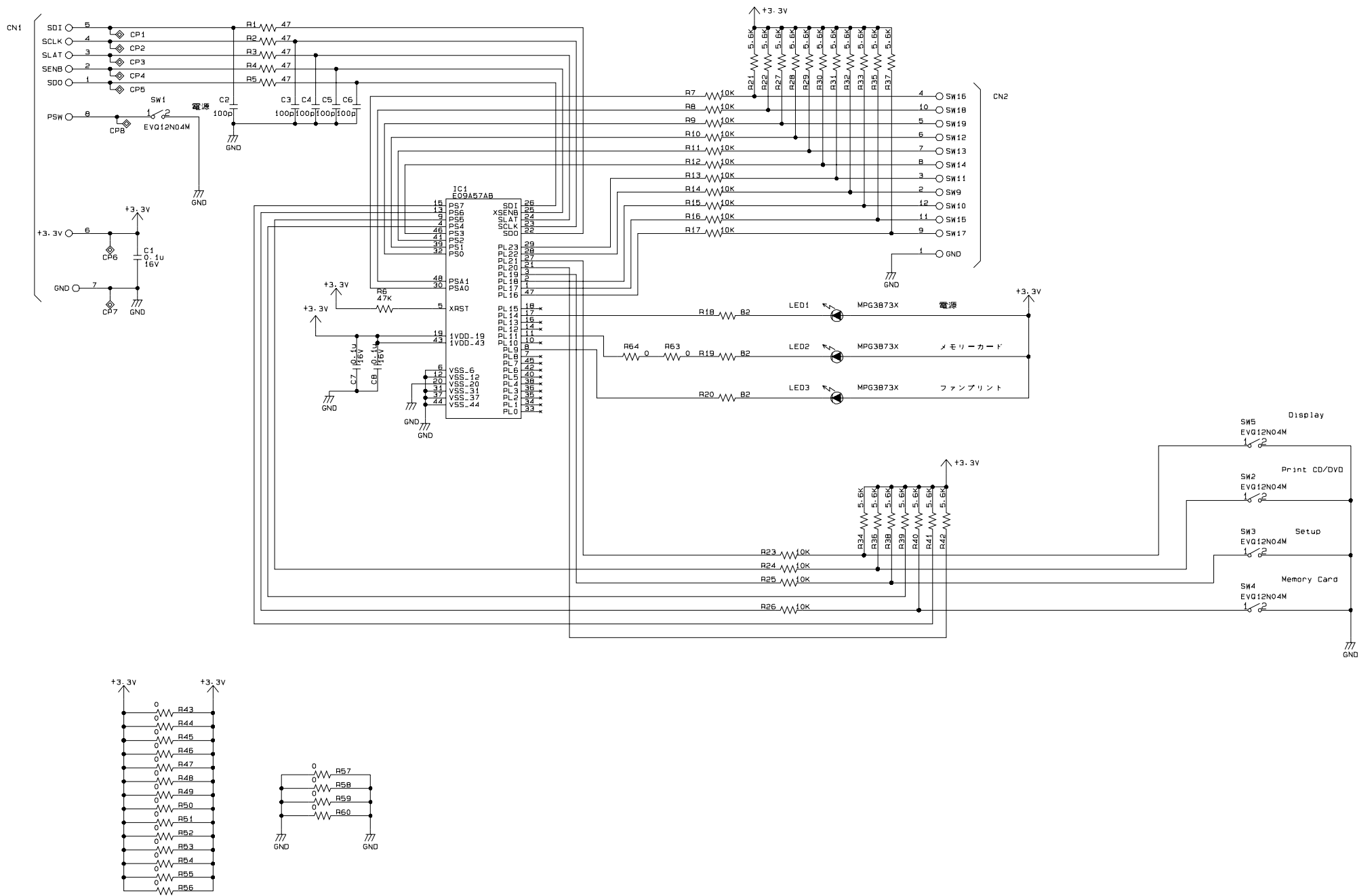

Model : PM-D870
 Stylus Photo R360/R380/R390
 Board : C658 PNL
 Rev. : A
 Sheet : 1/1

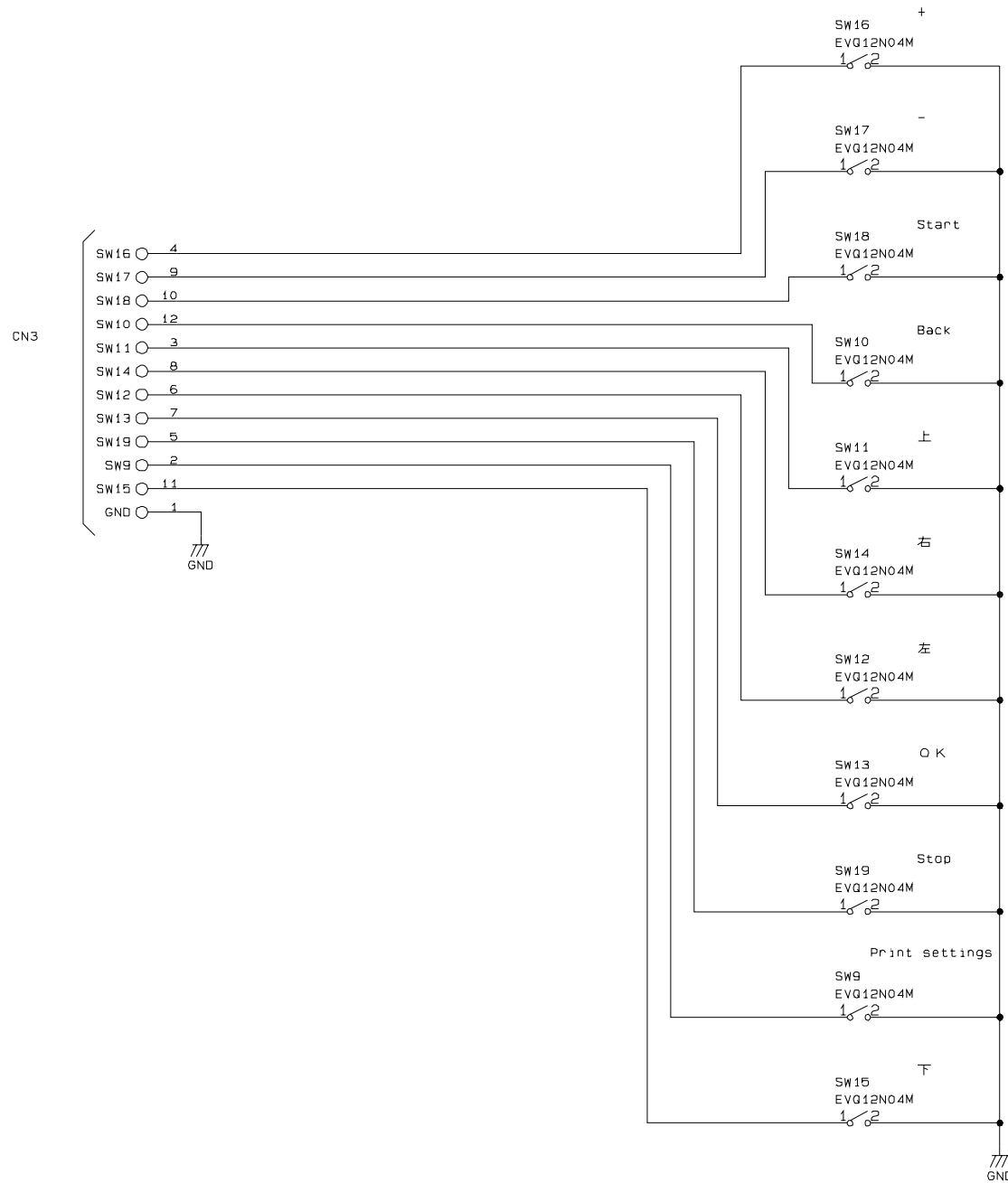

Model : PM-D870
 Stylus Photo R360/R380/R390
 Board : C658 PNL-B
 Rev. : A
 Sheet : 1/1

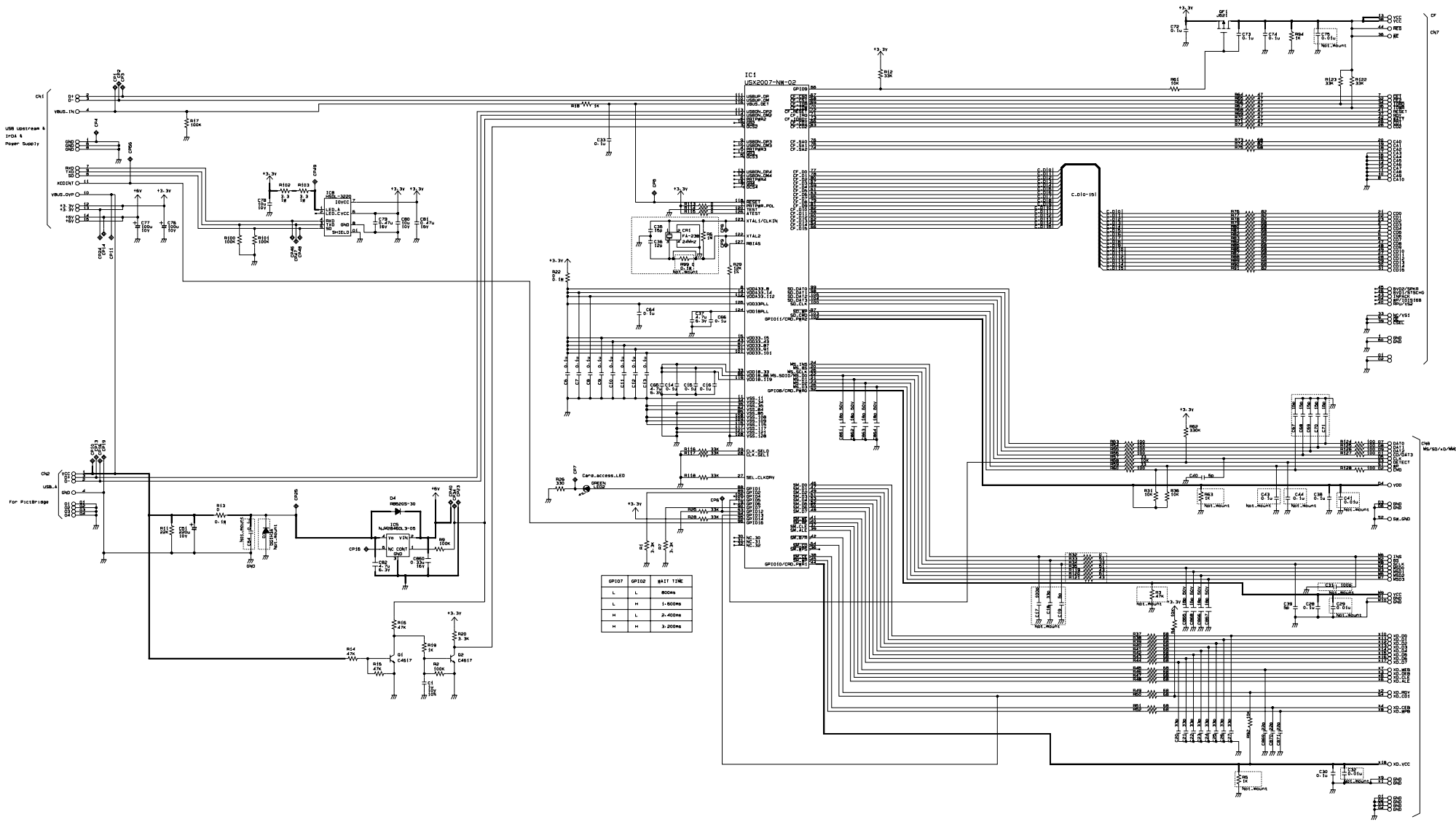

Model : PM-D870
 Stylus Photo R360/R380/R390
 Board : C658 STG
 Rev. : B
 Sheet : 1/1

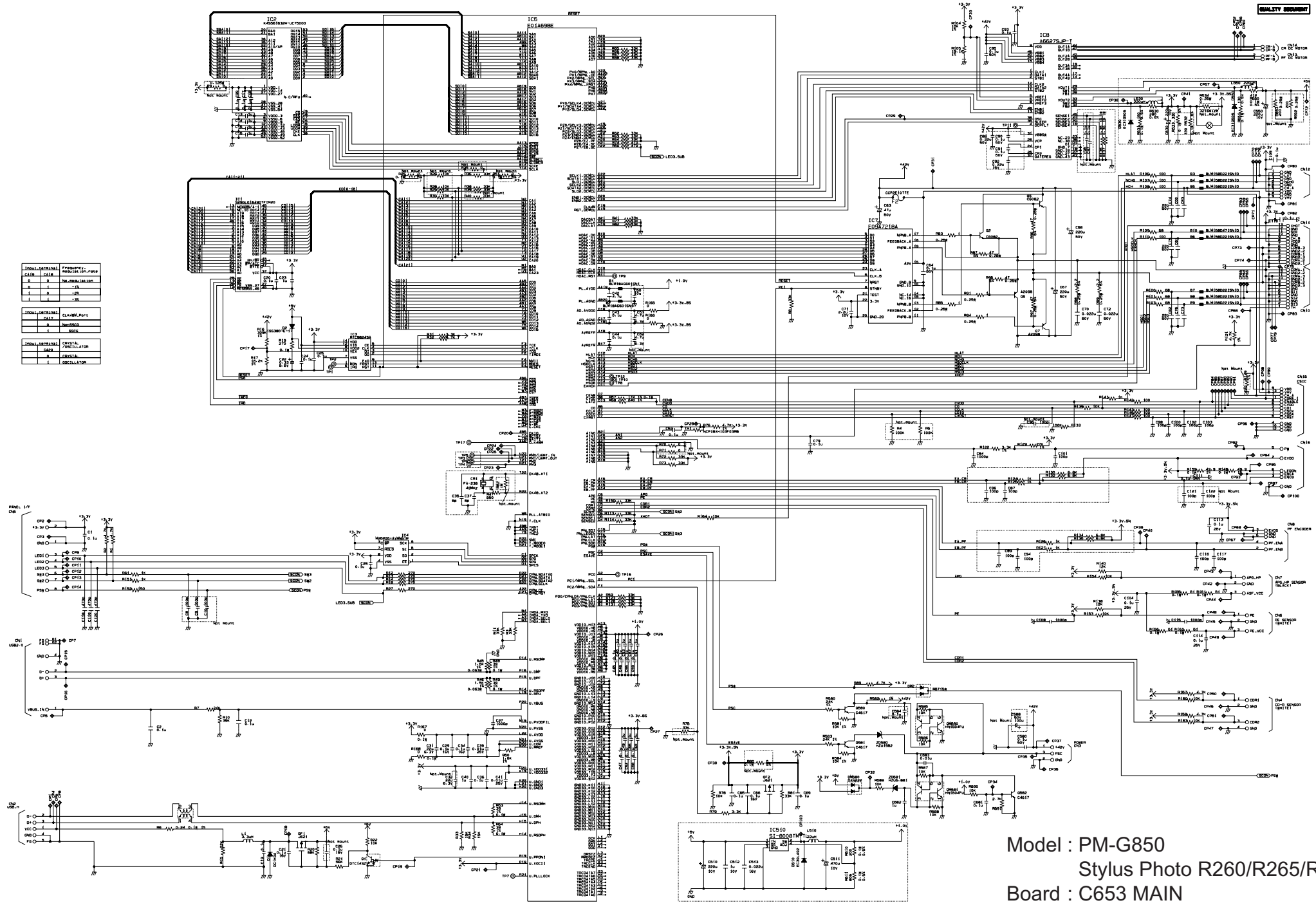

IC1-6225UC7800	FUNCTION	REF
1	DATA	DATA
2	DATA	DATA
3	DATA	DATA
4	DATA	DATA
5	DATA	DATA
6	DATA	DATA
7	DATA	DATA
8	DATA	DATA
9	DATA	DATA
10	DATA	DATA
11	DATA	DATA
12	DATA	DATA
13	DATA	DATA
14	DATA	DATA
15	DATA	DATA
16	DATA	DATA
17	DATA	DATA
18	DATA	DATA
19	DATA	DATA
20	DATA	DATA
21	DATA	DATA
22	DATA	DATA
23	DATA	DATA
24	DATA	DATA
25	DATA	DATA
26	DATA	DATA
27	DATA	DATA
28	DATA	DATA
29	DATA	DATA
30	DATA	DATA
31	DATA	DATA
32	DATA	DATA
33	DATA	DATA
34	DATA	DATA
35	DATA	DATA
36	DATA	DATA
37	DATA	DATA
38	DATA	DATA
39	DATA	DATA
40	DATA	DATA
41	DATA	DATA
42	DATA	DATA
43	DATA	DATA
44	DATA	DATA
45	DATA	DATA
46	DATA	DATA
47	DATA	DATA
48	DATA	DATA
49	DATA	DATA
50	DATA	DATA
51	DATA	DATA
52	DATA	DATA
53	DATA	DATA
54	DATA	DATA
55	DATA	DATA
56	DATA	DATA
57	DATA	DATA
58	DATA	DATA
59	DATA	DATA
60	DATA	DATA
61	DATA	DATA
62	DATA	DATA
63	DATA	DATA
64	DATA	DATA
65	DATA	DATA
66	DATA	DATA
67	DATA	DATA
68	DATA	DATA
69	DATA	DATA
70	DATA	DATA
71	DATA	DATA
72	DATA	DATA
73	DATA	DATA
74	DATA	DATA
75	DATA	DATA
76	DATA	DATA
77	DATA	DATA
78	DATA	DATA
79	DATA	DATA
80	DATA	DATA
81	DATA	DATA
82	DATA	DATA
83	DATA	DATA
84	DATA	DATA
85	DATA	DATA
86	DATA	DATA
87	DATA	DATA
88	DATA	DATA
89	DATA	DATA
90	DATA	DATA
91	DATA	DATA
92	DATA	DATA
93	DATA	DATA
94	DATA	DATA
95	DATA	DATA
96	DATA	DATA
97	DATA	DATA
98	DATA	DATA
99	DATA	DATA
100	DATA	DATA

Model : PM-G850
 Stylus Photo R260/R265/R270
 Board : C653 MAIN
 Rev. : C
 Sheet : 1/1

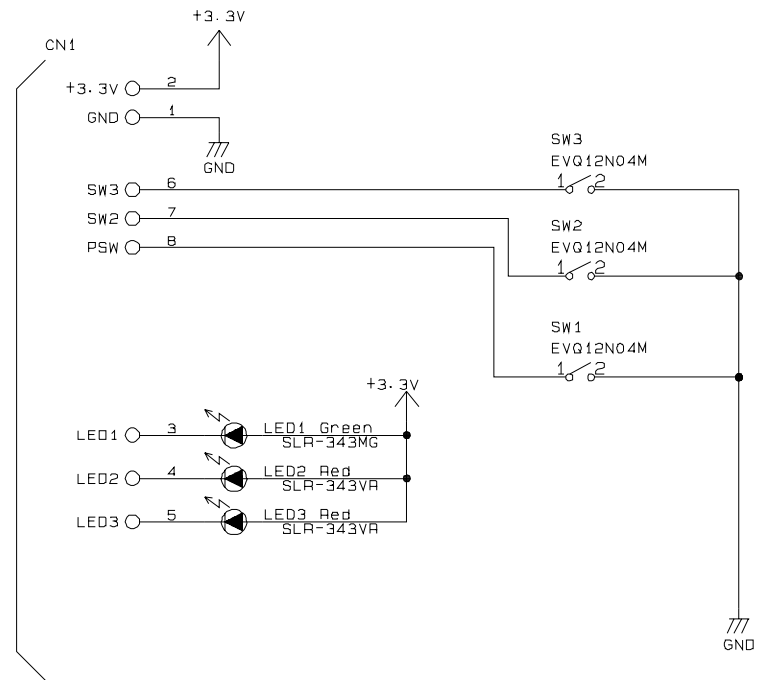

Model : PM-G850
 Stylus Photo R260/R265/R270
 Board : C653 PNL
 Rev. : A
 Sheet : 1/1

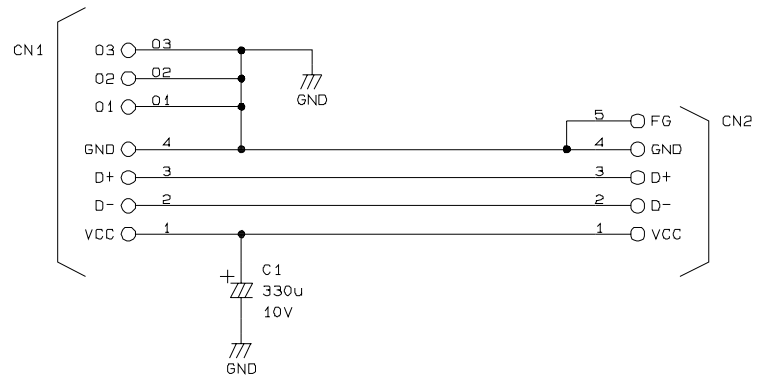

Model : PM-G850
Stylus Photo R260/R265/R270
Board : C653 I/F
Rev. : A
Sheet : 1/1

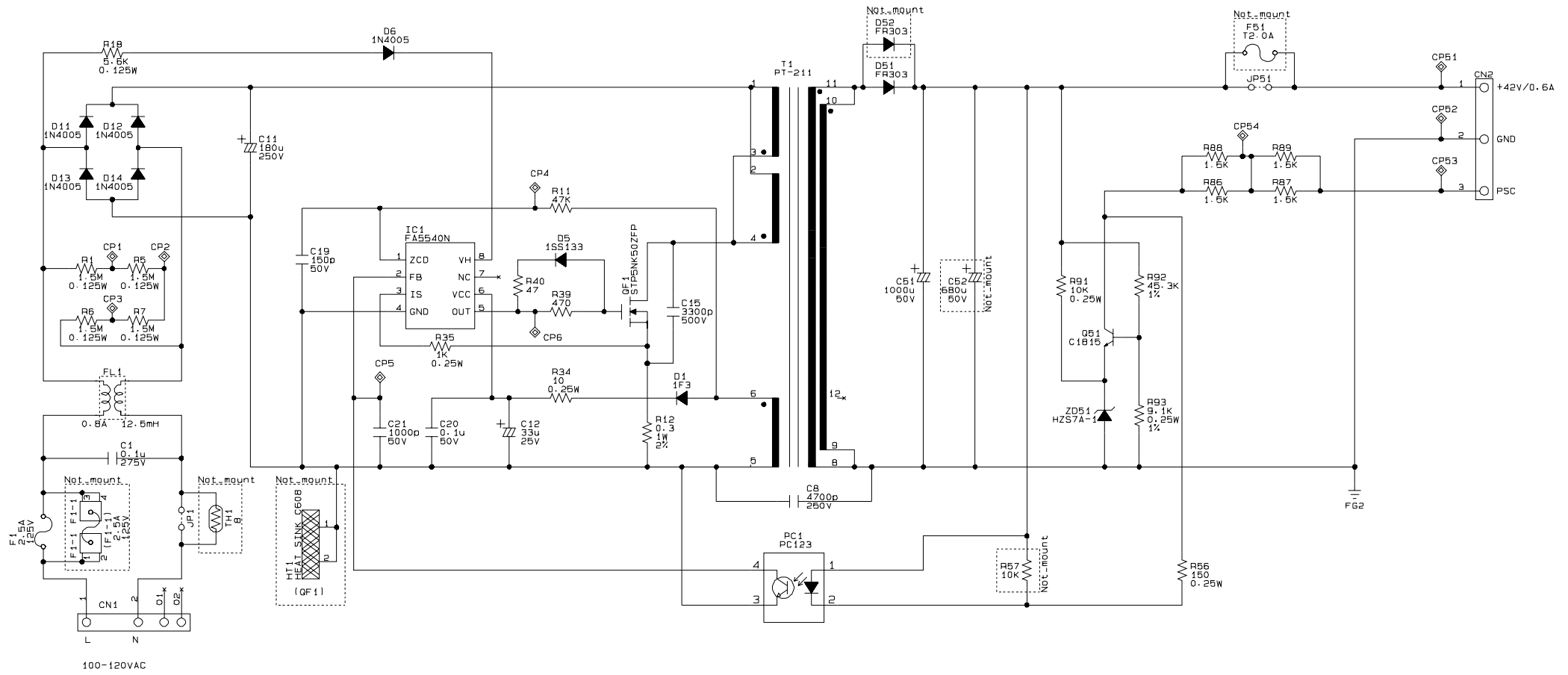

Model : PM-D870/PM-G850
 Stylus Photo R360/R380/R390
 Stylus Photo R260/R265/R270
 Board : C653 PSB
 Rev. : B
 Sheet : 1/1

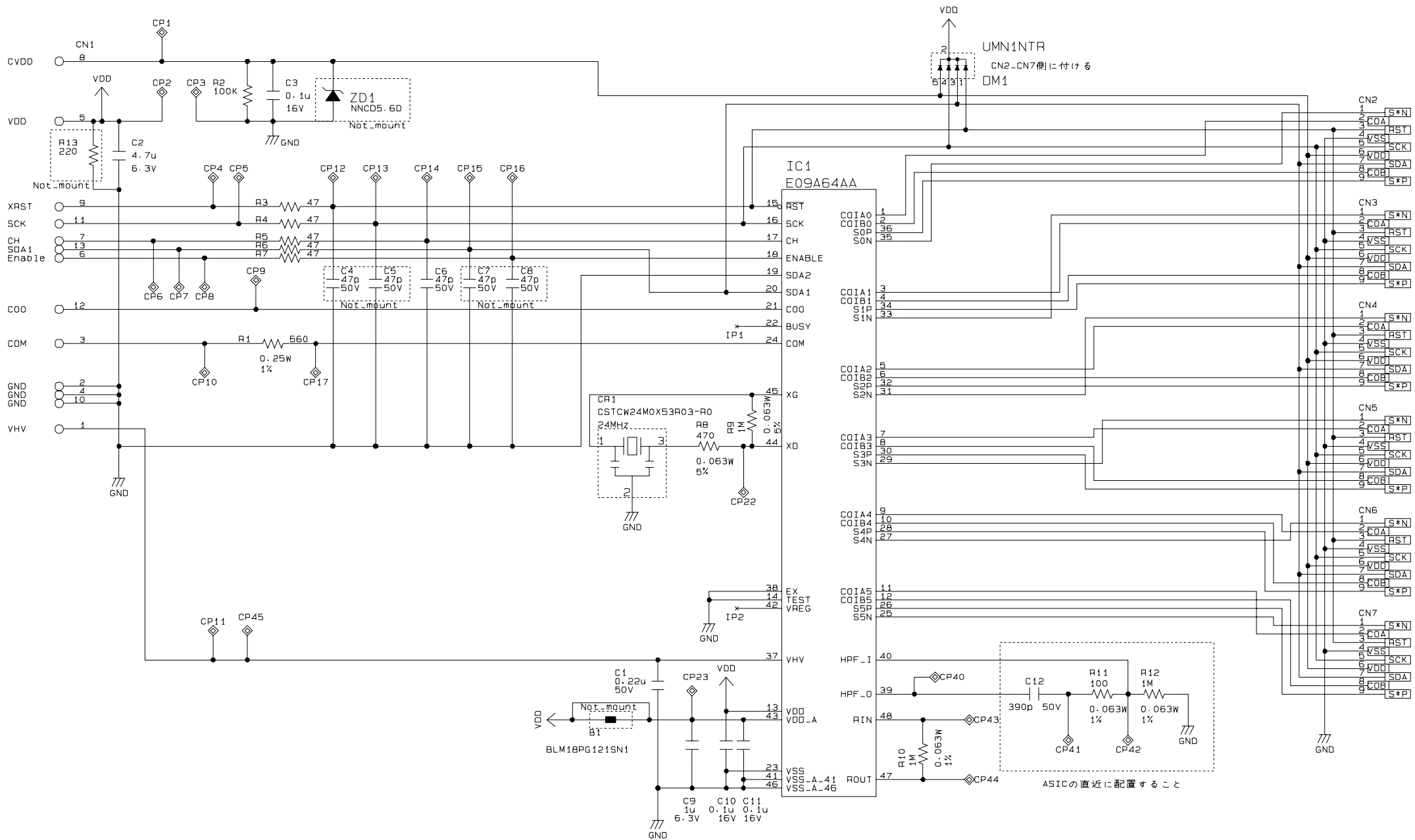

Model : PM-D870/PM-G850
 Stylus Photo R360/R380/R390
 Stylus Photo R260/R265/R270
 Board : C653 HEAD
 Rev. : B
 Sheet : 1/1